



espresso coffee machines

MANUAL FOR USE AND MAINTENANCE

S 40 Seletron



TANTI STILI...UNA PASSIONE

EC Declaration of Conformity to the Directive 97/23/EC Pressurised Equipment Directive – PED

MANUFACTURER: **La Spaziale Spa**

ADDRESS: **Via E. Duse, 8 - Casalecchio di Reno (BO) ITALIA**

HEREBY DECLARES THAT:

On the espresso coffee machine **S40** the pressure assembly is composed of a boiler complete with safety and adjustment devices, used for rapid preparation of espresso coffee, steam and infusions.

This assembly conforms to the essential requirements of the Directive 97/23/EC and to national laws acknowledging it, following the conformity assessment procedure below:

- NI 9887 Regulations, ISPESL collection rev. 95

The assembly also satisfies the following EC Directive:

- 2006/42/CE - 2006/95/CE - 2004/108/CE

Cacciari Franca (CEO)



WEEE

Disposal of the equipment by the users within the European Community (WEEE) in compliance with the article 13 of the legislative decree issued on 25 July 2005, nr151 "Implementation of the directives 2002/95/CE,2002/96/CE e 2003/108/CE, concerning the decrease in the usage of dangerous substances in the electrical and electronic equipment and the disposal of waste".

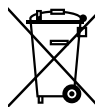

The symbol of the crossed waste bin indicated on the equipment or on the packaging means that the product at the end of its lifetime must be disposed of separately from all the other waste.

The separate collection of this equipment coming at the end of its lifetime is organized and run by the importer/distributor. The user who should have to dispose of such equipment should get in touch with the importer/ distributor and follow the procedure they have adopted for the separate disposal of the equipment coming at the end of its lifetime. The proper separate disposal of disused equipment so that it can be recycled and treated according what is environmentally compatible contributes to avoid possible negative effects on the Environment and on Health and allows the reutilization and/or the recycling of the materials the equipment is composed of.

The improper disposal by the user causes the enforcement of the administrative sanctions according to current regulations.

Behind the coffee bar counter, every seconds precious, cup after cup.

The coffee machine is the instrument which dictates the rhythm.

It has to be technological, reliable, ergonomic. It has to be attractive, fit in with the furnishings, the shades of colour, the lights. It makes your work run smoothly. You have thus more time to think, to express your own creativity, to better fulfil the art of the barman.

In planning the new **S40, La Spaziale** top of the range, the technicians set themselves these goals.

They observed gestures, pauses and work spaces to come up with the ergonomic aspects.

Then, they dressed the elements of functionality with a high-class aesthetic, as elegance and practicality may blend in an excellent design. Inside the machine, they placed a technological heart, whose components interact with extreme precision, guided by avant-garde electronics.

An ample display with LCD graphics guarantees total interaction between the barman and the engineer responsible of maintenance, who in every single moment has full control of the machine. There is rapid and easy access to the technological heart of the **S40**. Accurately programmed control cycles allow to reduce maintenance time and ensure that the machine is kept in a state of maximum efficiency.

A personalised card gives access to the management programmes, making the **S40** unique and secure in every aspect. The updates of the software controlling the machine are extraordinarily simple. Energy consumption is limited, as after 20 minutes of inactivity the machine goes into "stand-by". But this is only the start of a journey. The opportunities offered by digital technologies are constantly growing and the S40 is ready to seize them all.

La Spaziale S.p.A.

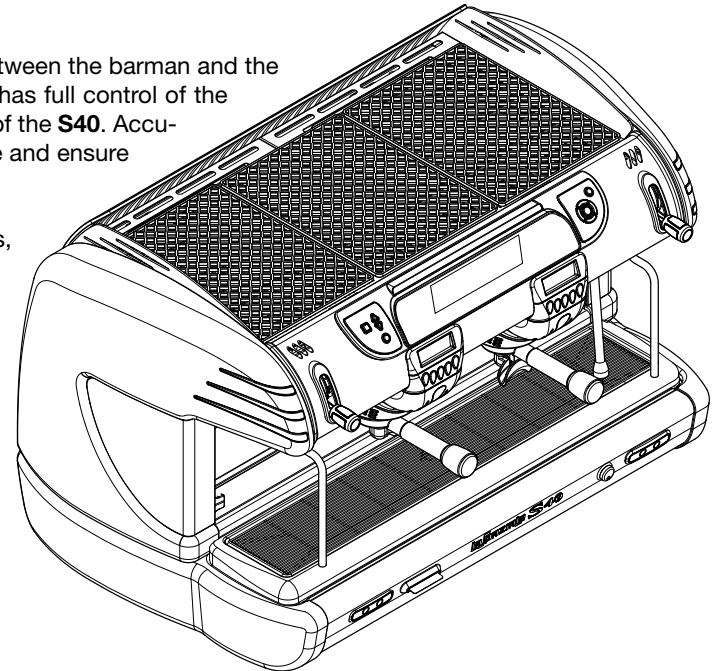

INDEX

1. GENERAL DESCRIPTION OF THE MACHINE	5	5.8 FUNCTION OF THE THERMOSTAT-REGULATED CUP WARMER SURFACE.....	35
1.1 DESCRIPTION OF THE MAIN COMPONENTS OF THE MACHINE	6	6. CLIENT PARAMETER PROGRAM ACCESS	36
1.1.1 Coffee dispensing touchpad	6	6.1 TIMER.....	38
1.1.2 Control panel.....	7	6.1.1 Daily programming	40
1.1.3 Display principale.....	8	6.1.2 Weekly programming	41
1.2 ORIENTATION OF THE MACHINE	9	6.1.3 Timer active.....	42
2. GENERAL ADVICE FOR THE INSTALLER	10	6.2 LEDs.....	43
2.1 GENERAL WARNINGS.....	10	6.3 CALENDAR	45
2.2 INSTALLATION REQUIREMENTS FOR THE USER.....	12	6.4 LANGUAGE.....	47
2.1 WARNING/TECHNICAL DATA LABELS AND NAMEPLATES APPLIED TO THE MACHINE.....	14	6.5 INFO	48
3 REMOVING THE PACKAGING	15	6.5.1 Serial number	49
3.2 STANDARD EQUIPMENT OF THE MACHINE.....	16	6.5.2 Software release.....	50
3.3 OPTIONAL ACCESSORIES (SUPPLIED ONLY AT THE REQUEST OF THE CUSTOMER)	17	6.6 BEEP	51
4. COMMISSIONING THE MACHINE	18	6.7 COUNTER	52
5 SWITCHING ON THE MACHINE	19	6.7.1 Reset counter.....	55
5.1 FILLING UP WITH WATER	20	6.8 GRINDING CONTROL.....	56
5.1.1 Water level indicator of the boiler.....	20	6.9 LOGO	58
5.2 APPLIANCE HEATING AND PREPARATION STAGE	22	6.10 CLEANING	59
5.3 COFFEE PREPARATION	24	6.11 EGS.....	63
5.4 STEAM DELIVERY.....	27	6.12 SCREENSAVER.....	65
5.5 DELIVERING WATER TO PREPARE INFUSIONS.....	28	7. SOFTWARE UPDATING.....	67
5.5.1 Semiautomatic mode.....	29	8. ROUTINE APPLIANCE MAINTENANCE TO BE PERFORMED BY THE USER.....	70
5.5.2 Automatic mode.....	29	8.1 DAILY AT THE END OF THE JOB.....	70
5.6 AUTOMATIC MILK EMULSION WITH TEMPERATURE ADJUSTMENT - M.A.T. (OPTIONAL).....	30	8.2 EVERY TWO WEEKS.....	72
5.7 BOOST FUNCTION.....	32	9. LIST OF PROGRAMMABLE FUNCTIONS (TECHNICAL ASSISTANCE SERVICE ONLY).....	73
5.7.1 Economy FUNCTION.....	34		

10. MANAGEMENT OF THE ALARMS	78
10.1 ALARM MESSAGES VISUALISED ON THE MAIN DISPLAY	78
10.2 ALARM MESSAGES VISUALISED ON THE FRONT DISPLAY	78
10.2.1 Alarms relative to the auto-level system	79
10.3 MESSAGES VISUALISED ON THE COFFEE DISPENSING GROUPS' DISPLAYS	87
11. TECHNICAL DATA.....	89

1. GENERAL DESCRIPTION OF THE MACHINE

The **S40** coffee machine is designed and manufactured by **LA SPAZIALE S.p.A.** to increase the profitability of the buffet bar service by reducing operating costs to the minimum.

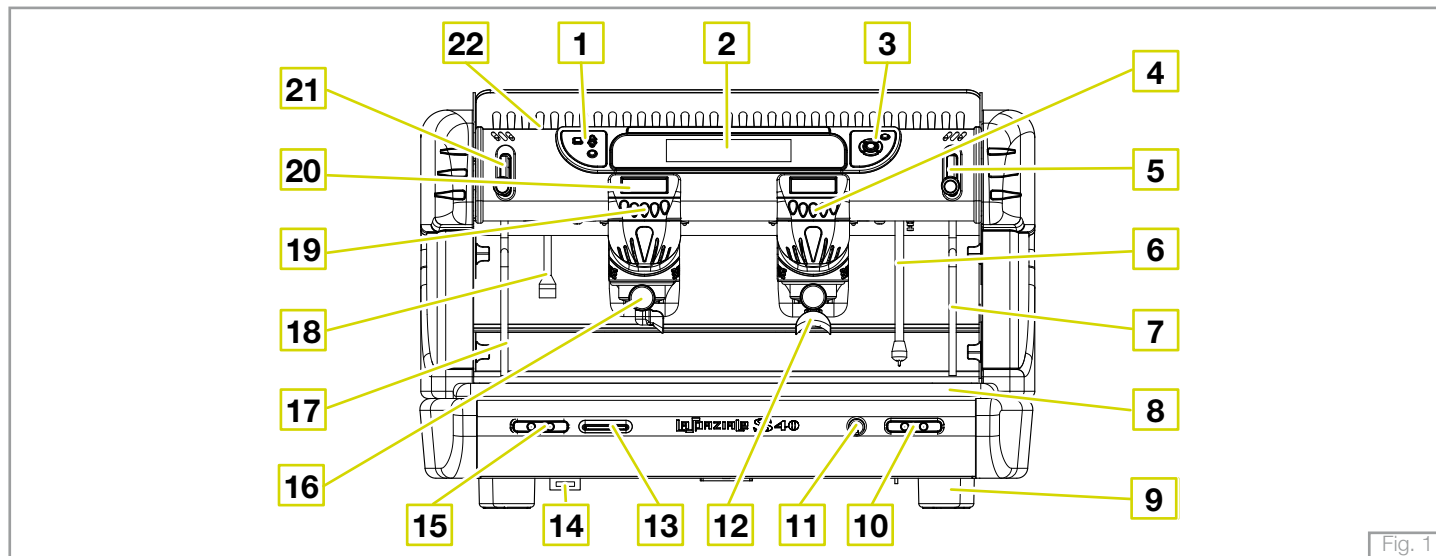

Fig. 1

LEGEND

- | | | |
|---|--|--|
| <ul style="list-style-type: none"> 1. Selector touchpad 2. Main display 3. Navigation touchpad 4. Coffee dispensing group 1 touchpad 5. Right steam tap 6. Steam wand with incorporated temperature sensor (M.A.T.) (optional) 7. Right steam wand | <ul style="list-style-type: none"> 8. Water collection basin + grill 9. Adjustable foot 10. M.A.T. dispensing system touchpad (optional) 11. Main on/off switch 12. Two-cup filter holder 13. Card reader 14. SD/MMC card reader 15. Water supply touchpad for infusions | <ul style="list-style-type: none"> 16. One-cup filter holder 17. Left steam wand 18. Water supply wand for infusions 19. Coffee dispensing group 2 touchpad 20. Coffee dispensing group display 21. Left steam tap 22. Cup warmer plate |
|---|--|--|

1.1 DESCRIPTION OF THE MAIN COMPONENTS OF THE MACHINE

1.1.1 Coffee dispensing touchpad

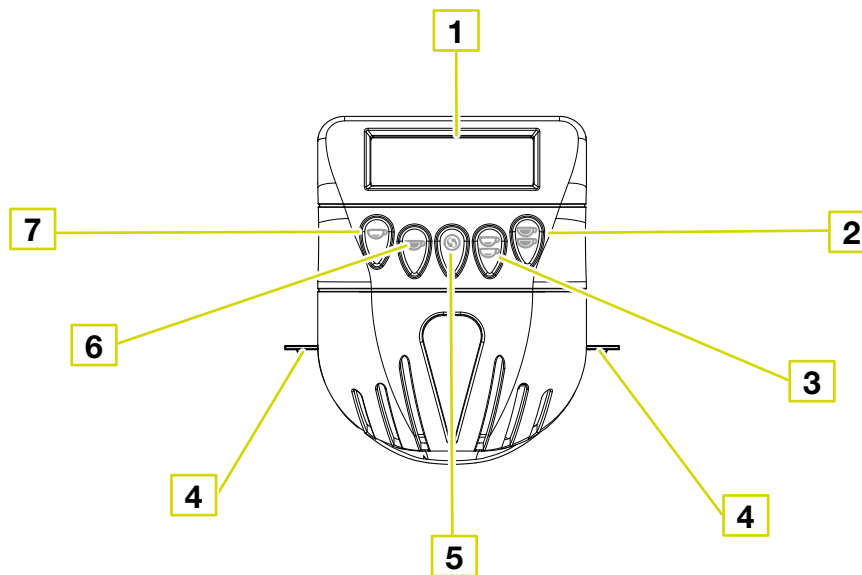

Fig. 2

LEGEND

- 1. Display
- 2. 2 long coffees' key
- 3. 2 short coffees' key
- 4. Work surface illumination LED
- 5. Continuous delivery key
- 6. 1 long coffee key
- 7. 1 short coffee key

1.1.2 Control panel

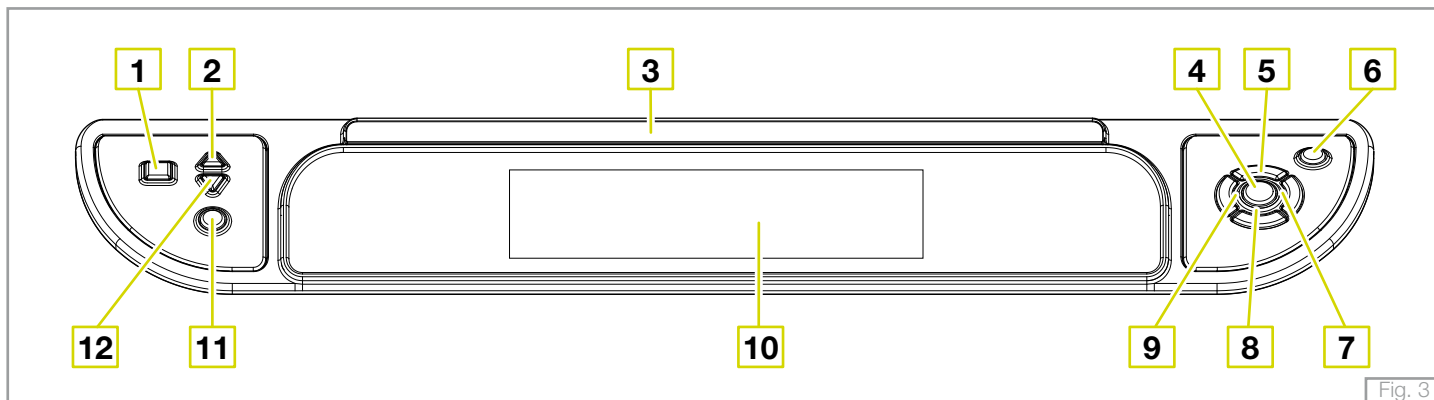

Fig. 3

LEGEND

1. Cup warmer heating plate on/off key
2. Cup warmer heating plate temperature increase key
3. Logo
4. OK key
5. Scroll up arrow key
6. Stand-by/on key
7. Scroll right arrow key
8. Scroll down arrow key
9. Scroll left arrow key
10. Main display
11. On/off manual boost key
12. Cup warmer heating plate temperature decrease key

1.1.3 Display principale

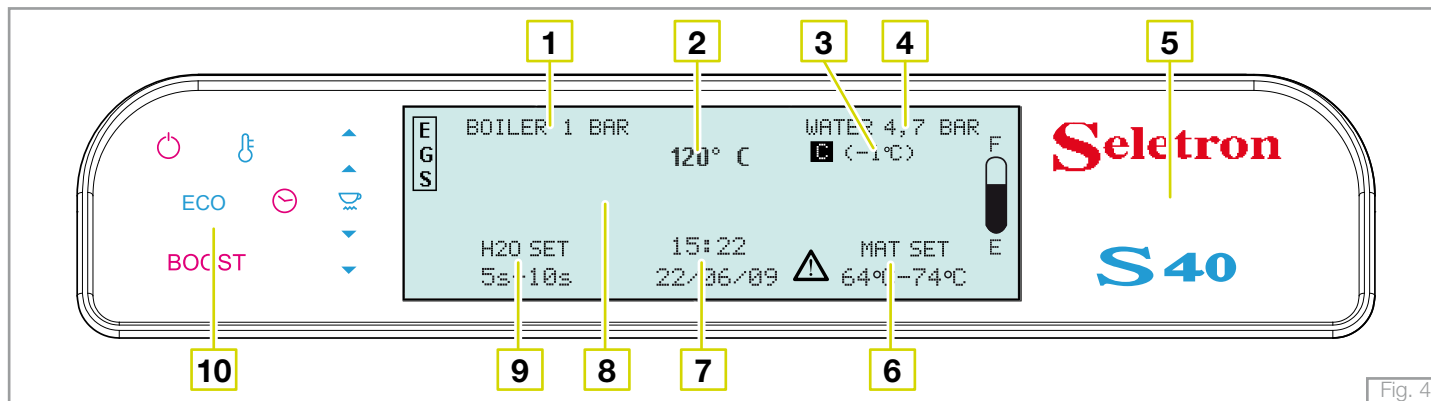

Fig. 4

LEGEND

1. Boiler pressure
2. Boiler temperature
3. Compensation temperature
4. Water supply or motor pump pressure
5. Series and model of the machine
6. M.A.T. temperature setting programme system (optional)
7. Hour and date
8. Message area
9. Hot water dispensing times setting programme for infusions
10. Signal symbols

SYMBOLS

	Stand-by
	Automatic level "ON"
	Temperature increase signal
	Cup warmer resistances "ON"
	Temperature decrease signal
ECO	Economy function activated
BOOST	Boost function activated
	Timer function "ON"

	EGS function "ON"
	Compensation function "ON"
	Level indicator
	"Alarms active" indicator

1.2 ORIENTATION OF THE MACHINE

To ensure that each reference to the various parts of the machine (front, rear, etc.) that appear in this manual is clear and unmistakable, the orientation of the machine is as represented in this figure.
Any exceptions to this rule will be specified.

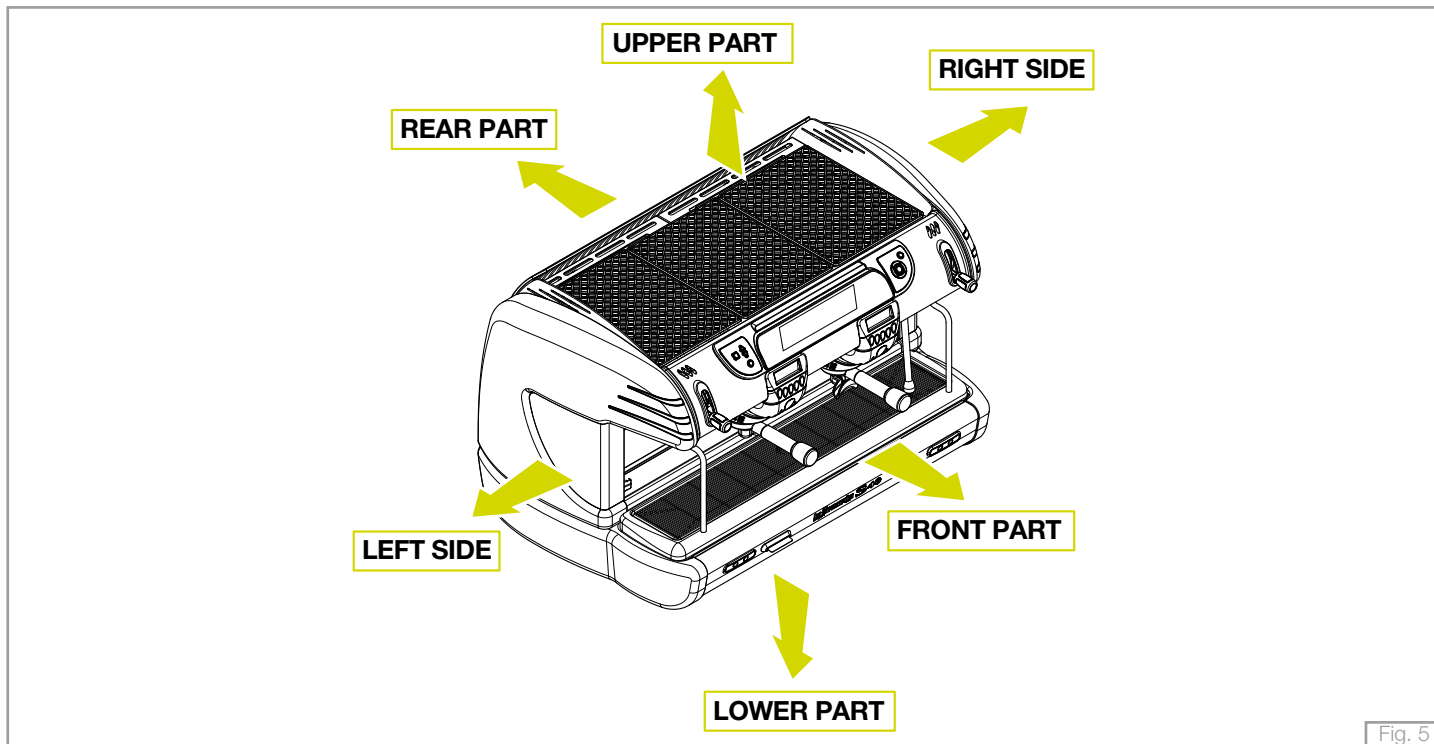

Fig. 5

2. GENERAL ADVICE FOR THE INSTALLER

Read carefully the instructions and warnings contained in this manual and in the “**INSTRUCTION MANUAL FOR THE INSTALLER**”, since they provide important indications concerning the installation of the appliance.

Attention!

The electric system, water system and drainage system **MUST BE** put in place by the customer in a suitable position to allow correct installation. The installation engineer cannot change the existing system put in place by the customer. See chapter 2.2: “Arrangements for installation provided by the customer”.

Attention!

The appliance must be installed where use and maintenance are restricted to trained staff.

2.1 GENERAL WARNINGS

Attention!

CAREFULLY READ THE FOLLOWING WARNINGS, WHICH OFFER IMPORTANT GUIDELINES FOR THE SAFE USE AND MAINTENANCE OF THE APPLIANCE.

The appliance must only be used for its intended purpose and it must be installed in a suitable place for its use. Any other use is therefore considered as improper and unreasonable.

The manufacturer cannot be held liable for any damage caused by improper, incorrect or unreasonable use. Installation must be carried out by qualified personnel according to current laws and to the manufacturer’s instructions. Incorrect installation may cause damage to people, animals or property for which the manufacturer cannot be held liable.



Danger!

The electrical safety of the appliance is fully achieved only after it has been correctly connected to an earthing system as required by the laws in force.

It is necessary to have the earthing connection checked by professionally qualified personnel. The manufacturer cannot be held liable for any damage caused by the lack or inefficiency of the system's earthing connection. The appliance has not been designed for outdoor use. It must only be operated in a place where the ambient temperature is between **+5°C** and **+40°C**.



Attention!

The use of any electrical appliance also requires observance of the following important regulations.

- Do not touch the appliance with wet or damp hands or feet.
- Do not use the appliance barefooted.
- Do not pull the power supply cord to unplug the appliance from the mains power.
- Do not allow children or unqualified persons to use the appliance.
- Access to the appliance's service area must be restricted to those persons with the relevant practical experience and familiarity with the appliance itself, especially in terms of safety and hygiene.
- Before carrying out any routine maintenance or cleaning operation, disconnect the appliance from the mains power and shut off the water supply tap.
- In the event of damage and/or malfunction of the appliance, switch it off completely without trying to make any direct repairs. Contact the nearest Service Centre authorised by the manufacturer.
- In order to guarantee the proper efficiency and operation of the appliance, it is fundamentally important to follow the manufacturer's instructions, and to follow a regular maintenance schedule.
- The appliance has **IPX2** protection against water and therefore, it cannot be installed in areas where it may be subject to jets of water.
- The appliance has **class I** protection against electric shocks.
- The noise emitted by the appliance during normal operation is less than **70 dB**.

! Attention!

Failure to comply with the above regulations could jeopardise the correct operation and safety of the appliance as well as its useful lifetime.

! Warning!

The appliance is supplied without a plug. It is supposed to be directly connected to the electric mains and therefore, it is necessary to fit a single-pole switch with contact opening of 3 mm or more beforehand, according to the regulations in force .

2.2 INSTALLATION REQUIREMENTS FOR THE USER

The machine has to be placed on a stable flat surface that can guarantee a safe position. Check this important requirement, since the manufacturer cannot be considered liable for any damage caused by the instability of the appliance. While preparing the systems, take into account that a hole is needed in the bearing surface in order to make all electric and water connections through the opening below where a water softener will need to be fitted, if recommended by the installation engineer.

A hole of **10 x 10 cm** is enough in the area (a) as indicated in Pict. 6.

The machine needs a minimum clearance of:

- height cm. 60
- width cm. 40
- depth cm. 40

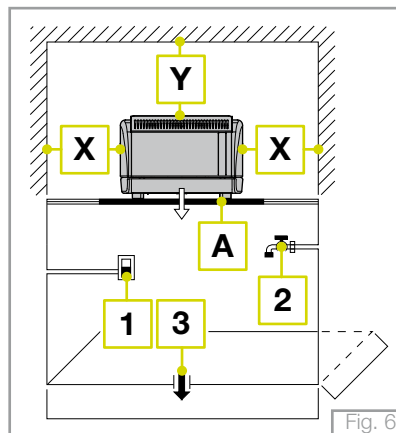

Fig. 6

Legend:

- 1** Single pole switch with an opening of at least 3 mm between contacts
- 2** Water supply tap
- 3** Drain siphon
- X** min. 20 cm.
- Y** min. 40 cm.
- Z*** min. 10 cm.

*) Distance between the back of the appliance and the wall.

- Between the water mains and the water inlet pipe of the appliance, there must be a tap to stop the water flow if necessary (2 - Pict.6).
- The water mains pressure must be within the range of **1 and 5 bar**.
- If this requirement is not met, please consult the manufacturer.
- The appliance is supplied without a plug. It is supposed to be directly connected to the electric mains and therefore, it is necessary to fit a single-pole switch with contact opening of **3 mm** or more beforehand, according to the regulations in force (1 - Pict.6).
- The drainpipe of the appliance must be directly connected to a suitable open drain siphon, previously installed by the customer (3 - Pict.6). Do not fit the drain pipe into basins or buckets placed under the counter as this will increase the possibility of forming dirt deposits and as a result, the spread of bacteria.



Attention!

The appliance is supplied without water in the boiler. This is to prevent serious damage if the appliance is exposed to low temperatures. The appliance must only be supplied with cold drinking water.

2.3 WARNING/TECHNICAL DATA LABELS AND NAMEPLATES APPLIED TO THE MACHINE.

In the figure below are shown the warning/technical data labels and nameplates positioned on the machine.



Dedicate the time necessary to familiarise yourself with these labels.

Ensure that they are readable and keep them clean or replace those that have deteriorated or illegible (both the text and the graphics).

Use a soft cloth, soap and water to clean the labels. Do not use solvents, petrol, etc.

If a label is positioned on a component part that has to be replaced, ensure that the new component has the same label applied or a new one.

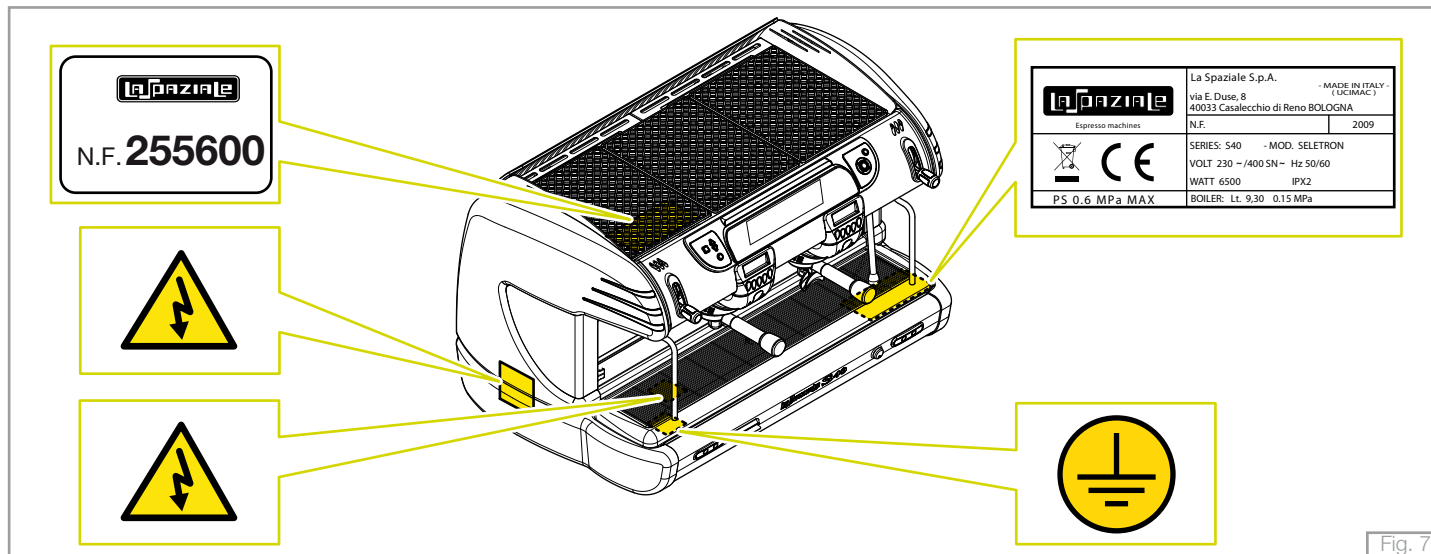

Fig. 7

3 REMOVING THE PACKAGING

After unpacking the machine, please check its integrity; in case of doubt, do not use it and consult the manufacturer. Packaging materials must not be left within children's reach since they are potentially dangerous.



Attention!

The appliance weight is more than 30 kg and therefore, it cannot be moved by a single person alone.



Take note!

Dispose of the packaging as per the norms in force of the country in which the machine is utilised.

3.2 STANDARD EQUIPMENT OF THE MACHINE

FILTER HOLDER

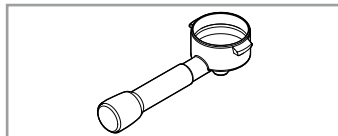

GROUPS	UNIT
2	x 3
3	x 4
4	x 5

1 CUP FILTERS

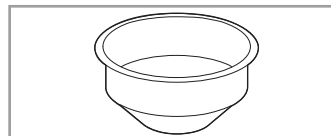

x 2

1 CUP SPOUT

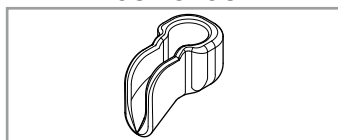

x 1

2 CUP FILTERS

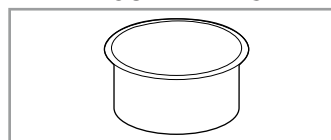

GROUPS	UNIT
2	x 4
3	x 6
4	x 8

2 CUP SPOUT

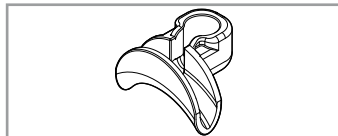

GROUPS	UNIT
2	x 2
3	x 3
4	x 4

1 SET OF SHOWER HEADS

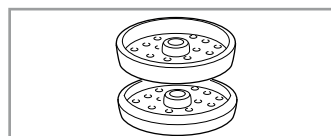

GROUPS	UNIT
2	x 2
3	x 3
4	x 4

CONNECTION WATER SUPPLY HOSES

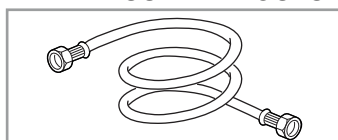

QUANTITY	LENGHT
1	150 cm
1	70 cm

1 BOX SPANNER FOR SHOWER HEAD REMOVAL

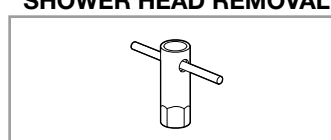

x 1

DRAINAGE HOSES

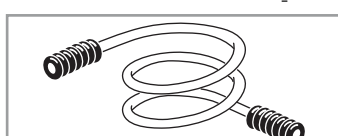

QUANTITY	LENGHT
1	150 cm

BRUSH

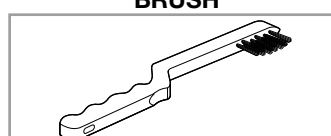

x 1

MANUAL COFFEE TAMPER

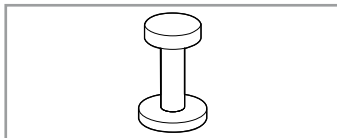

x 1

CUSTOMER CARD

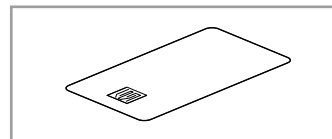

x 1

MOTOR PUMP

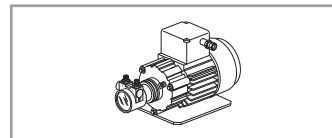

x 1 (When the pump is not incorporated in the machine)

3.3 OPTIONAL ACCESSORIES
(Supplied only at the request of the customer)

WATER SOFTENER

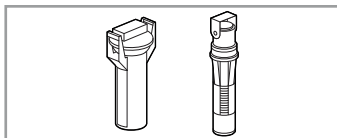

x 1

PRESSURE REDUCER

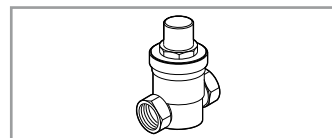

x 1

FILTER

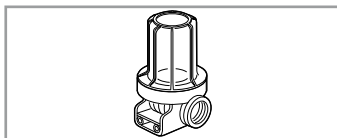

x 1

DETERGENT

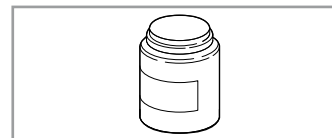

x 1

4. COMMISSIONING THE MACHINE

- a) Open the water supply valve as envisaged in the preparations for installation (**See Fig. 6 on page 12 - Ref. 2**).
- b) Check for any water leaks from the hosing/connections.
- c) Switch on the main breaker as envisaged in the preparations for installation (**See Fig. 6 on page 12 - Ref. 1**).

5 SWITCHING ON THE MACHINE

1. Move the switch positioned on the lower panel of the machine to the “I” position.

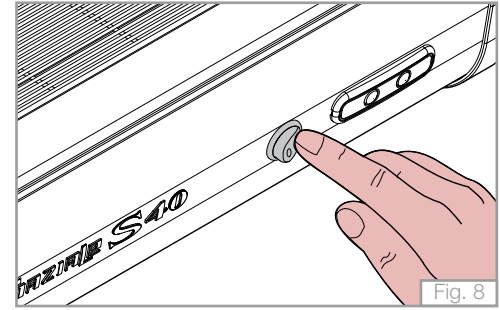



Fig. 8

2. The machine goes into **STAND-BY** mode and the warning lights (represented in the figure on the right) on the control panel come on (the  symbol flashes).

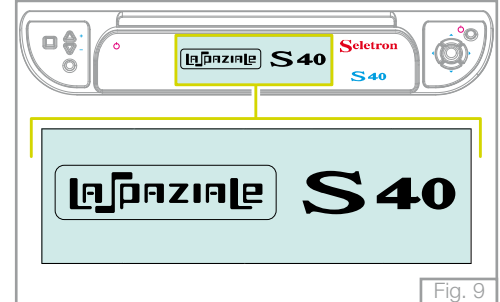

Fig. 9

3. Keep the stand-by key pressed for three seconds; a general check is carried out during which all symbols on the control panel light up without flashing for two seconds and the main display is subsequently visualised as shown in the figure.

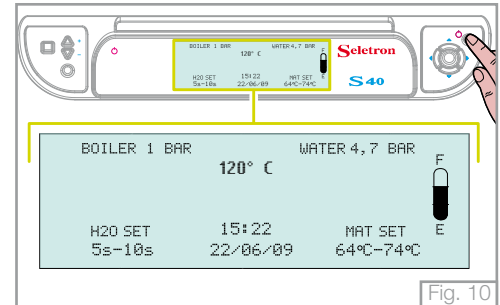

Fig. 10



Take note!

All functions that were active at the moment of switching off the machine the last time are memorised for the subsequent switching on of the machine.

5.1 FILLING UP WITH WATER

Three seconds after switching on, the machine automatically fills the boiler with water (Fig. 11).

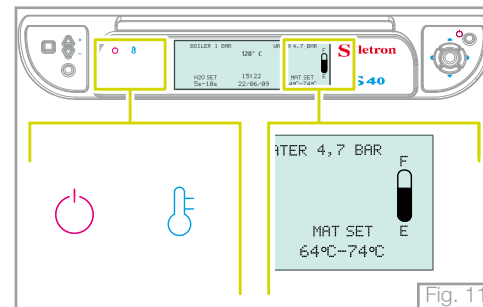

Fig. 11

When the boiler filling phase is finished, the relative filling warning light switches off and then a check/adjustment of the motor pump must be carried out.

5.1.1 Water level indicator of the boiler

The level indicator positioned on the right of the main display indicates the level of water in the boiler.

- EMPTY INDICATOR

When the level of water in the boiler has not reached the minimum level to ensure the functioning of the machine, the level indicator symbol is shown as in the figure on the right.

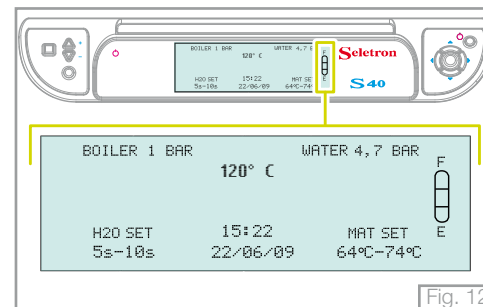



Fig. 12

- LEVEL "1" REACHED



The  symbol is visualised when the level of water in the boiler has reached the minimum level to ensure the functioning of the machine, but not at the level pre-established by the manufacturer.

- LEVEL "2" REACHED



The  symbol is visualised when the level of water in the boiler has reached the level pre-established by the manufacturer.

- FULL INDICATOR



The  symbol is visualised when the level of water in the boiler has reached an excessive level that does not ensure the correct functioning of the machine.

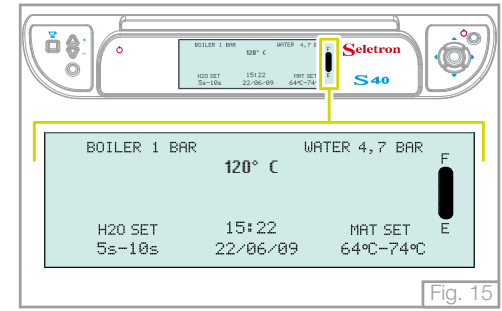
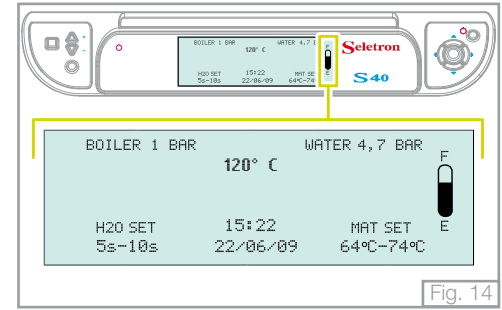
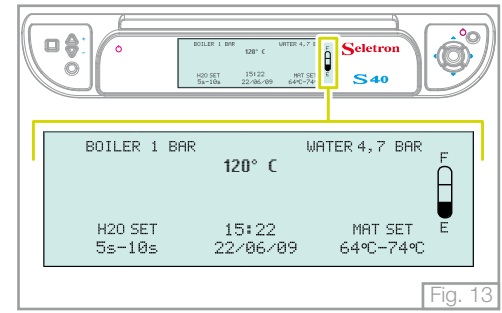

5.2 APPLIANCE HEATING AND PREPARATION STAGE

1. Attach the filter holders to the delivery groups.

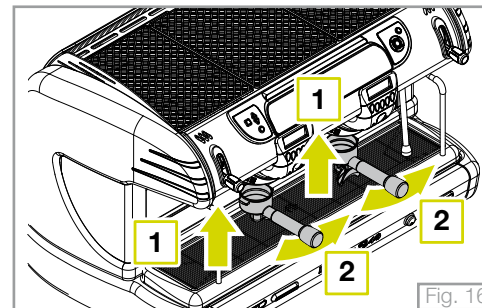

Fig. 16

2. Open the steam delivery valves by moving the dial upwards and leave them open: then move the steam wands over the grille.

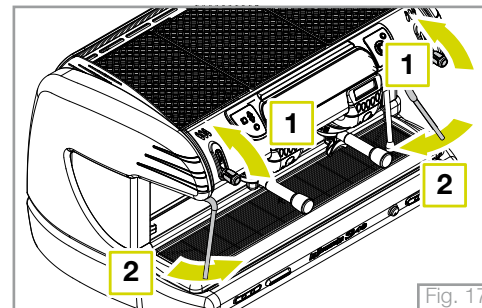

Fig. 17

3. Wait for steam to come out of the relevant wands (approx, 15-20 minutes) then close the steam valves by returning the dial to the initial position.

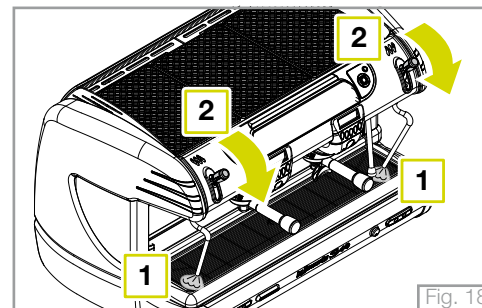
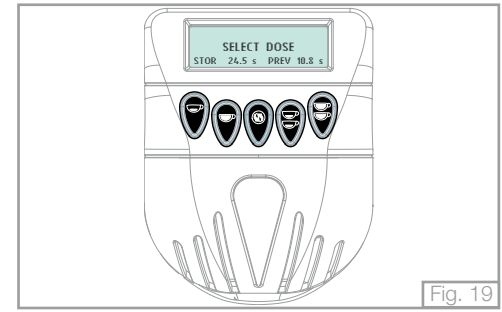
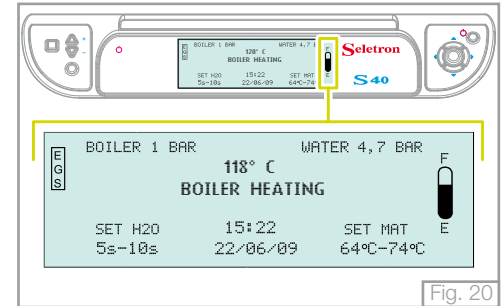

Fig. 18

- Wait for the appliance to reach the running temperature.
The groups display will show the screen opposite.



Each time that the temperature inside the boiler drops to below the SET LEVEL, the main display will show the screen opposite.



Take note!

The running temperature is the temperature of the boiler during normal operation.

- The appliance is ready to use.

5.3 COFFEE PREPARATION

1. Remove a filter holder from the delivery group.

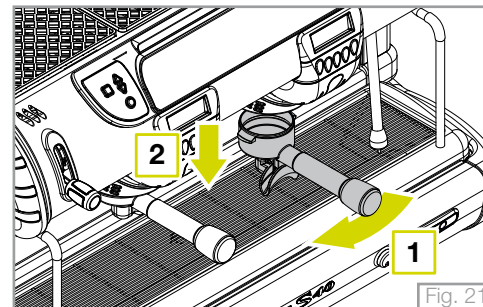

2. Fill with ground coffee, taking care not to leave any coffee powder residues on the top edge of the filter holder, then press it using the special coffee press supplied.

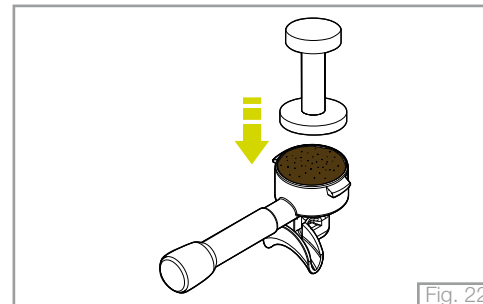

3. Re-insert the filter holder firmly but not excessively.

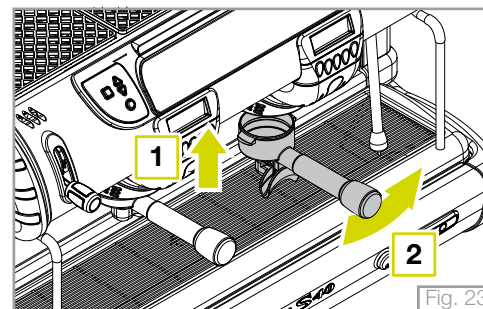

- Place one or two cups under the filter holder (according to whether you wish to pour 1 or 2 cups of coffee).

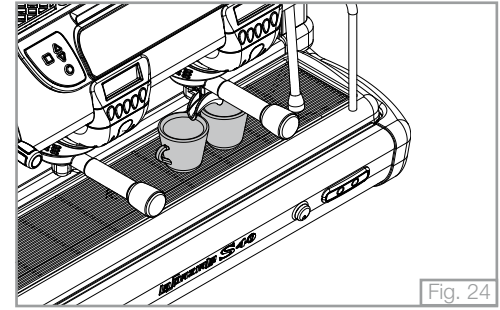

Fig. 24

- Press one of the delivery buttons (**A - B - D - E**) with programmed doses (during installation) or alternatively, use the button (**C**) for free flow delivery.

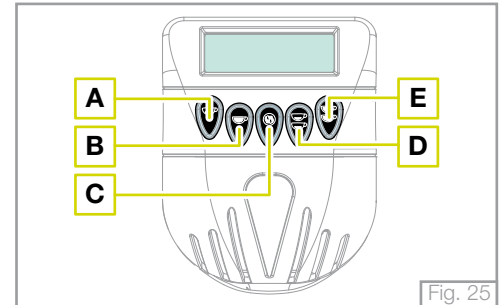

Fig. 25



Take note!

To stop a delivery commenced using one of the programmed dose buttons, press the (C) key on the same touchpad.

While delivering the coffee, the group display shows the screen opposite.

Represents the icon for the selected coffee dose with alongside, a bar to show the delivery progress.

The seconds stored during the dose programming stage for the selected dose (**MEM**) are shown under the bar, while alongside are the seconds indicating the actual progress of delivery (**DEL**).

Once delivery has finished, the group display will show the screen opposite.

The bottom of the display shows the seconds stored during the dose programming stage for the last dose selected (**MEM**) and alongside, the duration, in seconds, of the last dose delivered (**PREV**).

During free flow coffee delivery, the group display will show the time of the ongoing delivery in seconds.

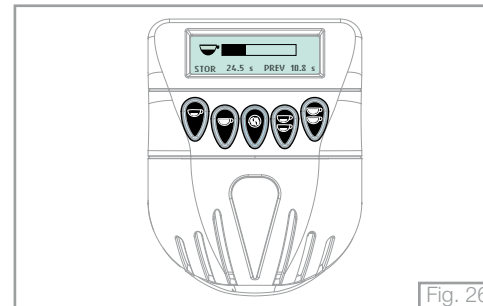

Fig. 26

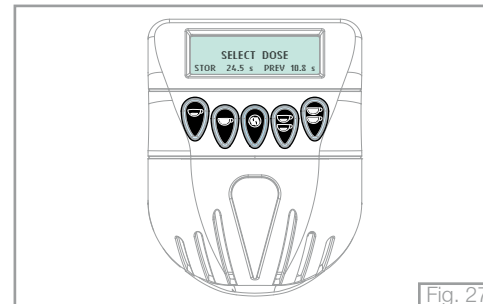

Fig. 27

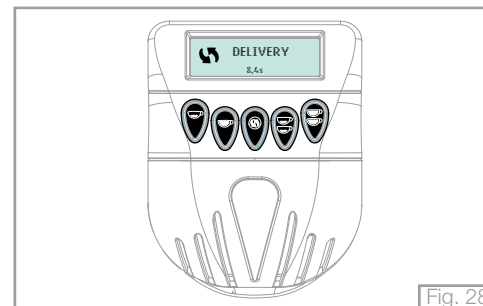

Fig. 28

5.4 STEAM DELIVERY

1. Insert the steam wand into a jug containing the beverage to be heated.

2. Move the dial of the corresponding steam wand upwards. Adjust the steam flow as required.

3. When the beverage is sufficiently hot, shut off the steam by moving the dial to its original position, remove the jug away from the steam wand and wipe off any residues immediately using a damp sponge.

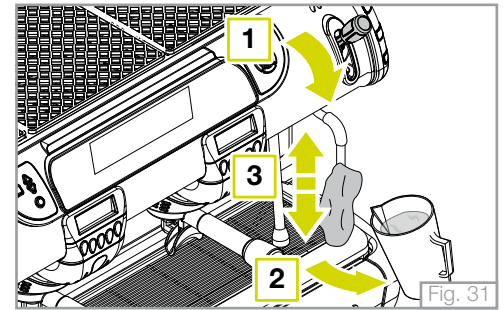
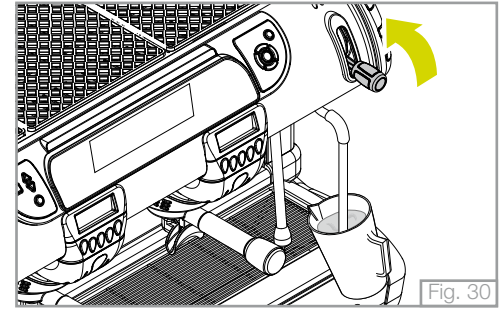
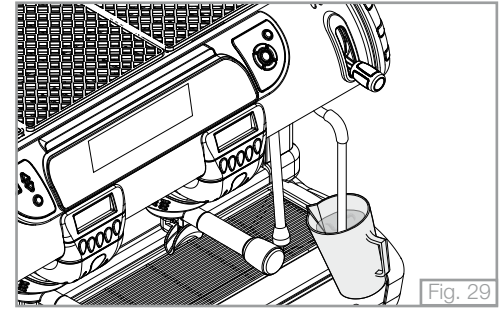

5.5 DELIVERING WATER TO PREPARE INFUSIONS

1. Place a jug under the hot water delivery wand.

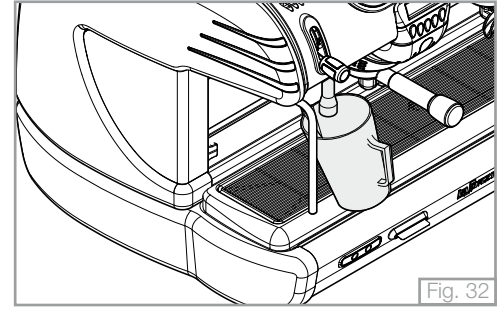

2. The hot water delivery wand is enabled from the touchpad on the left of the bottom front panel on the appliance.

The touchpad has 2 keys; the first serves to deliver 100% hot water, while the second serves to deliver hot water mixed to a set temperature that can be adjusted during the installation stages of the appliance.

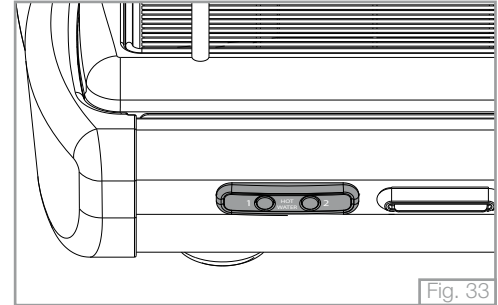

Attention!

Do not use the touchpad to deliver water before first placing the jug under the hot water wand. Danger of scalds and burns.

5.5.1 Semiautomatic mode

With the semiautomatic delivery mode enabled (programmed by the engineer); the touchpad keys will operate semi automatically (ON/OFF) and not timed.

5.5.2 Automatic mode

With the automatic delivery mode enabled (programmed by the engineer), the touchpad keys will operate automatically and delivery from the wand will take place for the time set during the appliance installation stage.

5.6 AUTOMATIC MILK EMULSION WITH TEMPERATURE ADJUSTMENT - M.A.T. (OPTIONAL)

The appliance can be equipped with a system that allows you to emulsify milk at a set temperature and completely automatically.

1. Insert the steam wand, complete with probe, into the jug of milk.
-
2. The M.A.T. wand is started up from the touchpad on the right-hand side of the bottom front panel of the appliance. The touchpad has 2 keys corresponding to 2 different SET temperatures programmed previously by the engineer. Delivery stops automatically when the temperature programmed during installation is reached. To stop steam delivery, press the button pushed to start it again.
-
3. While the wand with temperature probe is operating, the main display will show the SET temperature selected from the touchpad (left) and the actual temperature of the milk as it is being heated (right).

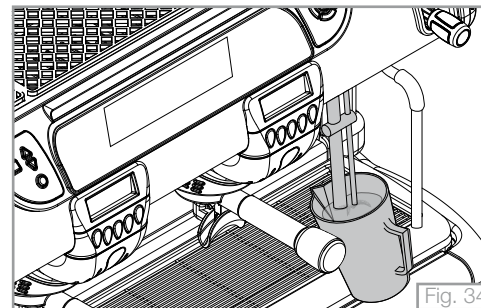

Fig. 34

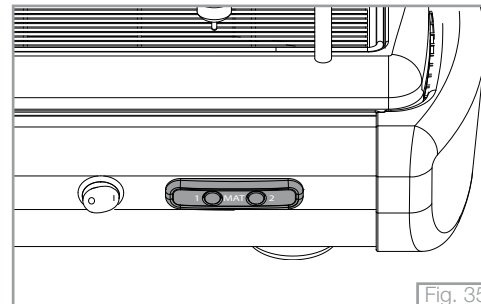

Fig. 35

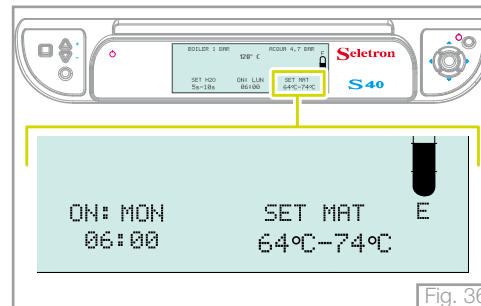
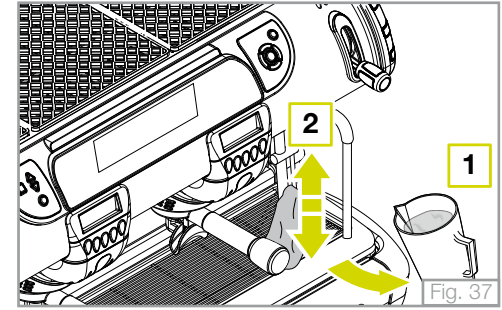

Fig. 36

4. At the end of the emulsion process, remove the jug and wipe any residues from the steam wand and temperature probe away immediately, using a damp sponge.



Attention!

Do not press the M.A.T. system delivery button before inserting the steam wand with temperature probe into the jug; danger of burns and scalds.

5.7 BOOST FUNCTION

This function has the purpose of optimising the management of the boiler resistances of the machine..

The “**Boost**” function permits taking advantage of the whole power available of the machine so as to have a greater thermal reset speed.

The menu also offers the possibility of activating the “**Manual**” and “**Automatic**” functions.

- MANUAL BOOST

The “**Boost**” function can be activated manually.

Pressing the “**BOOST**” key on the control panel, the “**Boost ON**” warning light indicates that the function is active.

Pressing the “**BOOST**” key again, the boost indicator light will switch off, indicating that the function is not enabled.

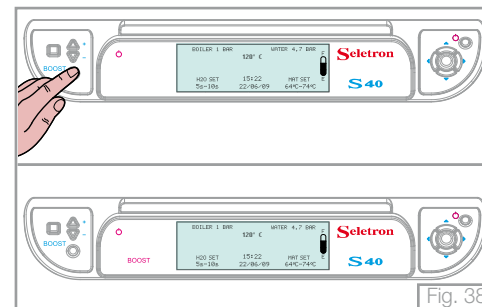

- AUTOMATIC BOOST

The “**Boost**” function can be activated also in automatic mode.

In automatic mode the function is active only when there is a drop in temperature in the boiler more than 5°C in respect of the set temperature.

The active function is visualised by the relative flashing warning light on the control panel

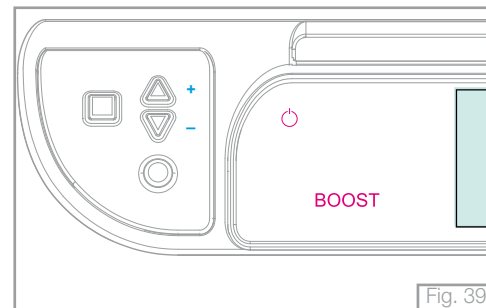

5.7.1 Economy FUNCTION

After 20 minutes with the machine at a standstill, the “**Economy**” function is automatically activated.

In this state, the total power of the appliance is reduced for the purpose of maintaining the running temperature.

When another delivery is requested, the “**Economy**” function is deactivated immediately.

The active “**Economy**” function is highlighted by the switching on of the relative warning light on the control panel.

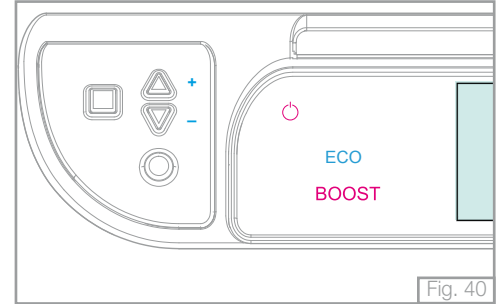

Fig. 40

5.8 FUNCTION OF THE THERMOSTAT-REGULATED CUP WARMER SURFACE

The machine is equipped with a thermostat-regulated cup warmer surface that keeps the coffee cups at a determined uniform temperature.

To activate the heating of the cup warmer surface, press the relative key on the control panel and check the switching on of the relative symbol ☕.

The symbol flashes whilst the surface is heating up and remains fixed when the set temperature has been reached. The temperature of the heating of the cup warmer surface can be increased or decreased using the increase and decrease keys positioned at the side of the heating key of the cup warmer surface.

The relative variation in temperature is visualised by the switching on/off of the (▲▼) symbols on the basis of the desired temperature step level.

Take note!

To modify the base temperature of the cup warmer surface (**Refer to “INSTRUCTION MANUAL FOR THE INSTALLER”**).

Attention!

Position the coffee cups right side up on the cup warmer surface situated on top of the machine.

Position the coffee cups on top of each other in a maximum of two rows.

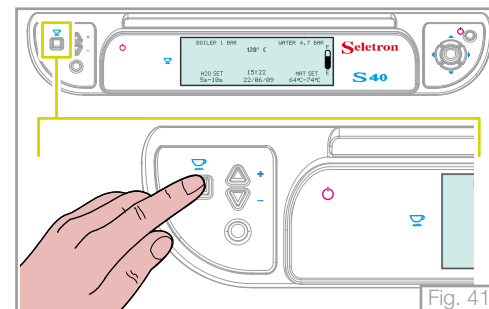

Fig. 41

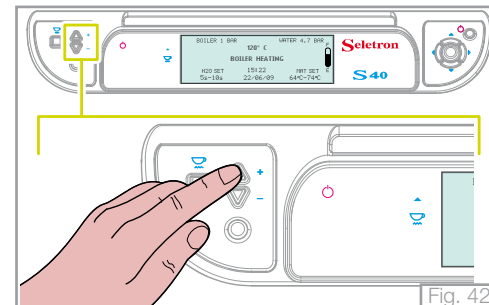

Fig. 42

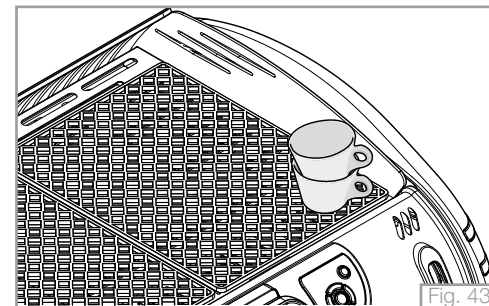
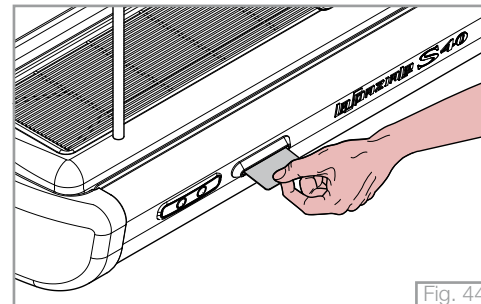

Fig. 43

6. CLIENT PARAMETER PROGRAM ACCESS

The “**Customer Card**” supplied with each appliance makes it possible to change some of its functions.

Insert the “**Customer Card**” into the special reader in the front panel (bottom left).



Access to the programming phase is confirmed by an acoustic signal and the main display visualises the “**Main menu**” viewing panel on the display. It is now possible to remove the “**Customer Card**” from the reader.

Take note!

Sixty seconds after pressing the last key, the machine automatically exits from the programming phase.

The data set previously is memorised.

The **“Main Menu”** contains 2 screens concerning the parameters to be programmed.

To pass from one viewing panel to another, use the navigation touchpad to position the cursor on the **“▶▶▶▶”** symbol and press the **“OK”** key.

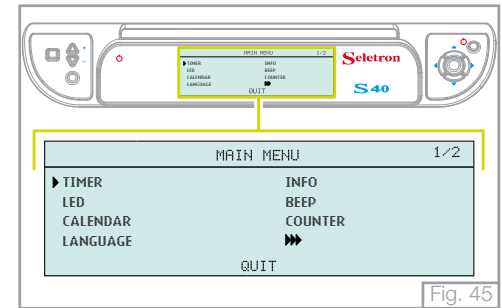

The display visualises the viewing panel on the right.

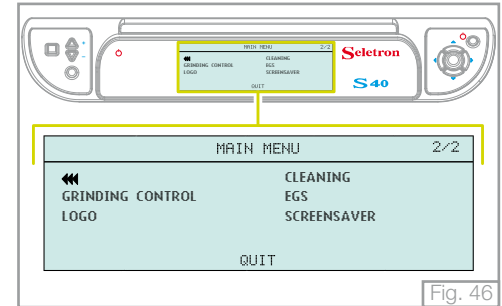

6.1 TIMER

This programme permits the programming of the switching on time and switching off time of the machine.

Position the cursor on the “**Timer**” menu and press “**OK**”; the display will show the screen opposite.

The function is enabled by default.

To enable the “**Timer**” function, position the cursor to “**ON**” and press the “**OK**” key to confirm.

Enabling the “**Timer**” function, the relative warning light on the control panel comes on.

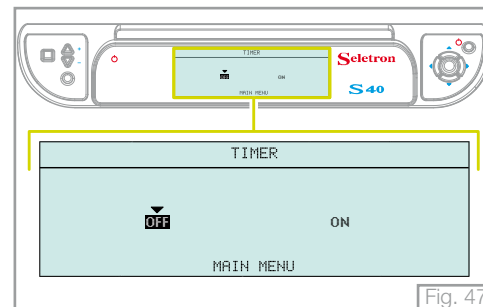

Fig. 47

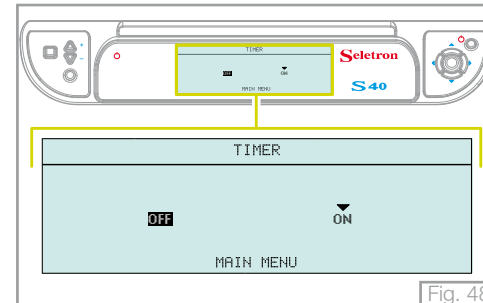

Fig. 48

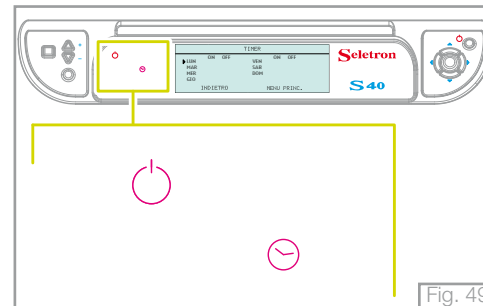

Fig. 49

The main display visualises the viewing panel on the right.

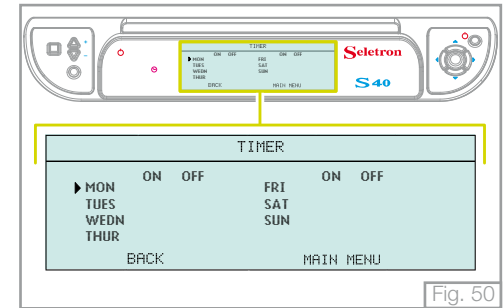

Fig. 50

Programming the “**Timer**” function to switch the machine on/off can be on a daily or weekly basis.

6.1.1 Daily programming

Using the navigation touchpad, position the cursor on the chosen day of the week for switching the machine on and press the “OK” key to highlight it.

Subsequently, position the cursor on the time to switch on the machine and set the time using the navigation touchpad (HH:MM).

Using the navigation touchpad, set the time for switching off the machine.

When the settings have been carried out, press the “OK” key to confirm.

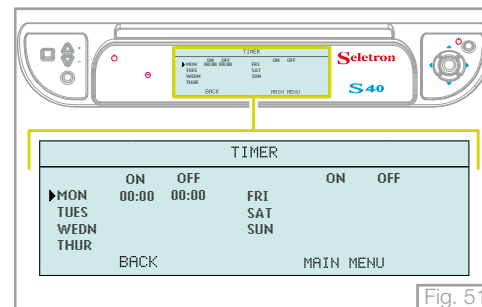

Fig. 51

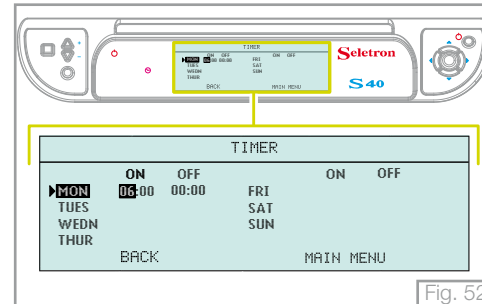

Fig. 52

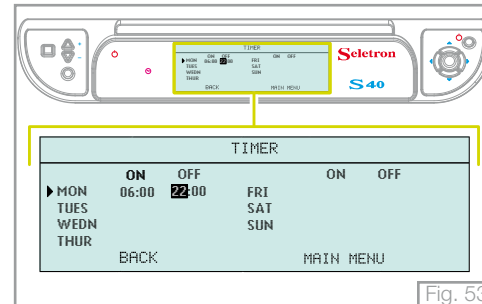

Fig. 53

6.1.2 Weekly programming

Using the navigation touchpad, position the cursor on the chosen day of the week for switching the machine on and press the “OK” key to highlight it.

Subsequently, position the cursor on the time to switch on the machine and set the time using the navigation touchpad (HH:MM).

When the settings have been carried out, press the “OK” key to confirm.

Using the navigation touchpad, set the day for switching off the machine.

The example on the right shows the machine has been set to come on at 06.00 on Monday and 22.00 on Saturday; Sunday the machine is switched off.

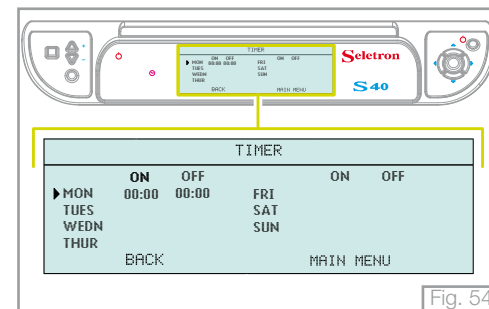

Fig. 54

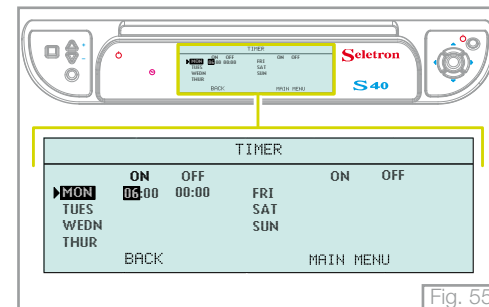

Fig. 55

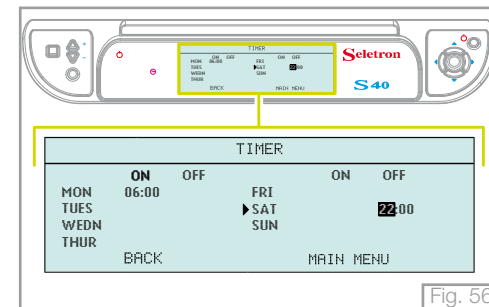

Fig. 56

6.1.3 Timer active

If the **“Timer”** function is activated, the main display alternates the visualisation of the date and current hour with the day and hour that the machine switches off.

When the machine is switched off by the timer, the main display shows the information on the right.

If it is necessary to switch the machine on before the pre-established time set by the **“Timer”** function, consecutively press the ON key on the control panel for three seconds. This operation automatically disenables the **“Timer”** function.

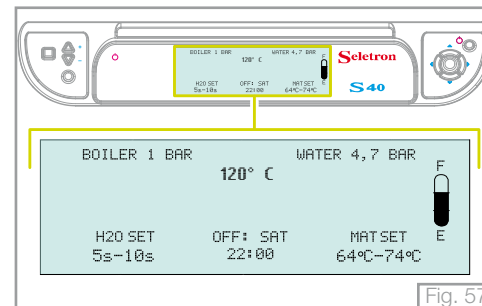

Fig. 57

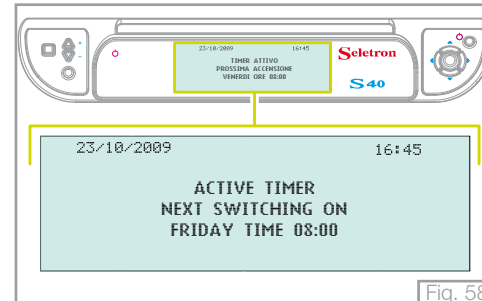

Fig. 58

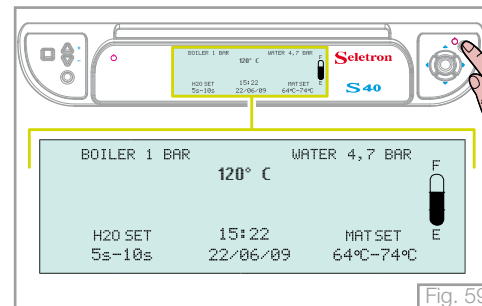

Fig. 59

6.2 LEDs

From the “**Main Menu**” page, use the navigation touchpad to select the “**LED**” menu and press “**OK**” to open it.

The display visualises the possibility of activating/deactivating the illumination of the work surface

This function is not enabled by default.

To enable this function, position the cursor on “**ON**” and press the “**OK**” key to confirm. The work surface is now illuminated by the LEDs positioned to the side of each coffee dispensing group.

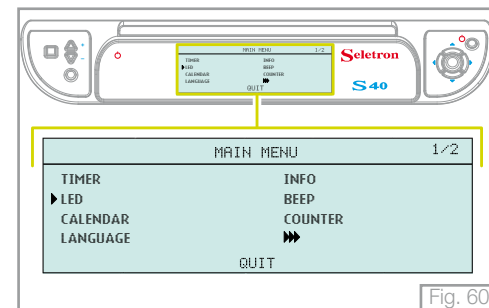

Fig. 60

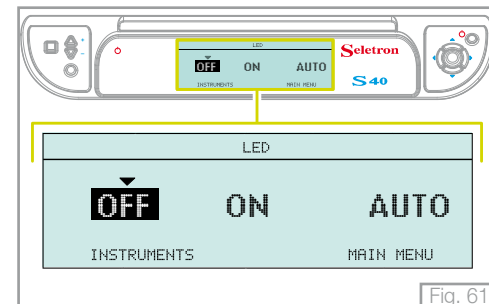

Fig. 61

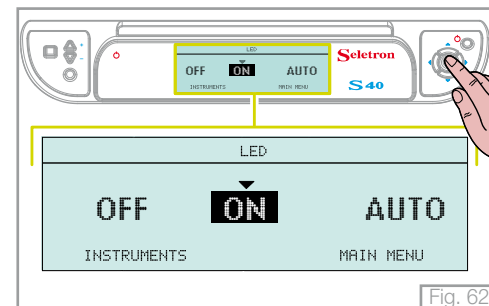
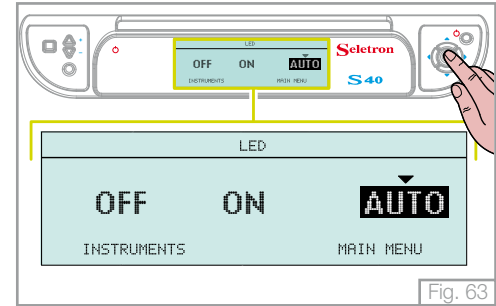

Fig. 62

Activating the “Auto” function, the two LEDs positioned at the side of each dispensing coffee group are switched on only during the coffee dispensing phase.



6.3 CALENDAR

From the “**Main Menu**” screen, use the navigation touchpad to select the “**Calendar**” menu and press “**OK**” to open it.

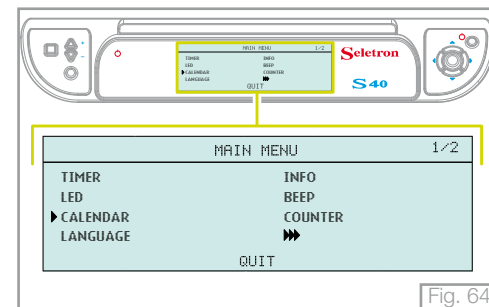

- DATE

Using the navigation touchpad, enter the “**Date**” menu and the display visualises the viewing panel on the right.

Pressing the **right/left arrows** of the navigation touchpad, select the parameter to modify. Press the “**OK**” key to highlight it and modify the parameter using the **up/down keys** of the navigation touchpad.

Press the “**OK**” key again to confirm the modification.

The visualisation of the day of the week is positioned underneath the date that is automatically updated on the basis of the date set.

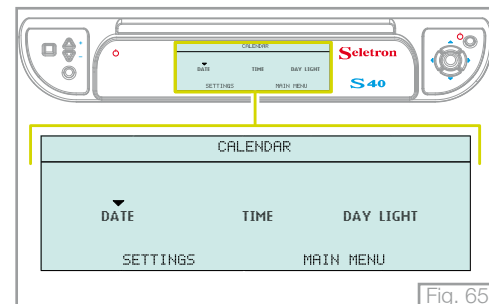

Having modified the parameters, position the cursor on the “**Settings**” menu using the navigation touchpad and press the “**OK**” key to return to the “**Settings**” menu or position the cursor on the “**Main menu**” and press the “**OK**” key to return to the main menu.

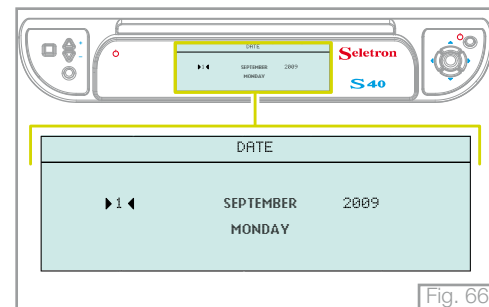

- HOURS

From the “Calendar” menu place the cursor on the inscription “**Hour**” and press the “**OK**” key to gain access.

The display visualises the actual time.

Using the **left/right arrow** keys of the navigation touchpad, select the parameter to modify and press the “**OK**” key to highlight it. Use the **up/down arrow** keys of the navigation touchpad to modify the parameter.

Having modified the parameters, position the cursor on the “**Calendar**” menu using the navigation touchpad and press the “**OK**” key to return to the “**Calendar**” menu or position the cursor on the “**Main menu**” and press the “**OK**” key to return to the main menu.

- SUMMER TIME

From the “**Calendar**” menu place the cursor on the inscription “**Summer time**” and press the “**OK**” key to gain access.

Using the navigation touchpad, position the cursor on the desired parameter and press the “**OK**” key to select it.

The function is disenabled by default.

When this function is enabled, the internal clock can be adjusted from winter time to summer time and vice versa on the last Sunday of March and the last Sunday of October.

Having carried out the time change, the main display visualises the viewing panel on the right for one minute.

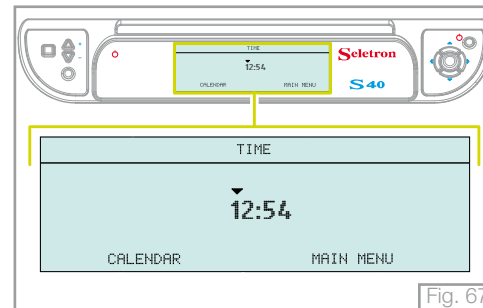

Fig. 67

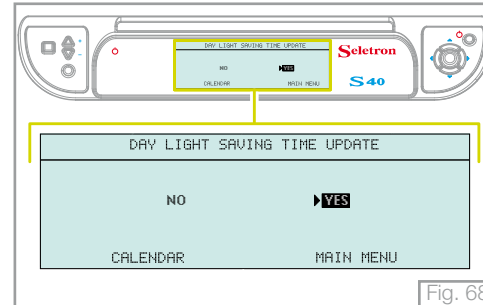

Fig. 68

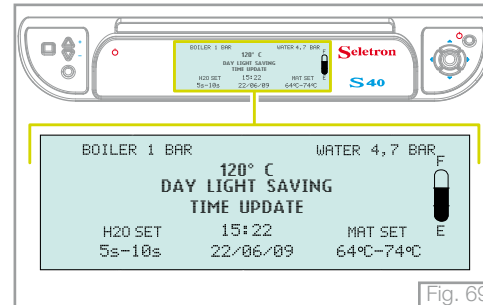

Fig. 69

6.4 LANGUAGE

From the “**Main Menu**” screen, use the navigation touchpad to select the “**Language**” menu and press “**OK**” to open it.

Pressing the **right/left arrow** keys of the navigation touchpad select the parameter to modify, press the “**OK**” key to highlight it and the **up/down arrow** keys of the navigation touchpad to modify the parameter.

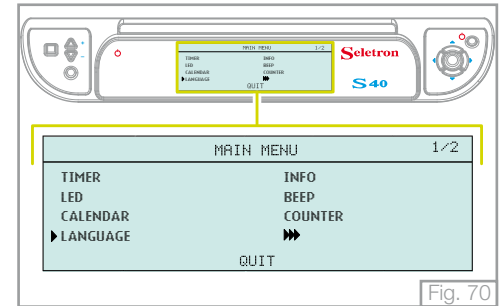

Fig. 70

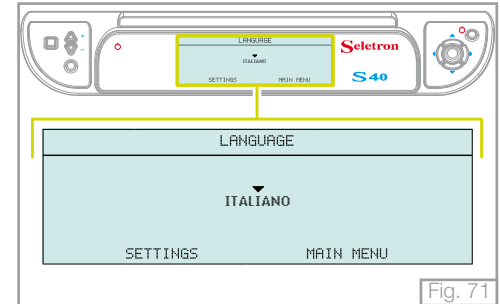

Fig. 71

6.5 INFO

From the “Main Menu” screen, use the navigation touchpad to select the “Info” menu and press “OK” to open it.

The “Info” menu contains a viewing panel displaying all the main information of the machine.

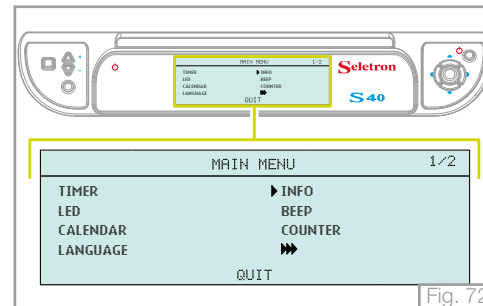

Fig. 72

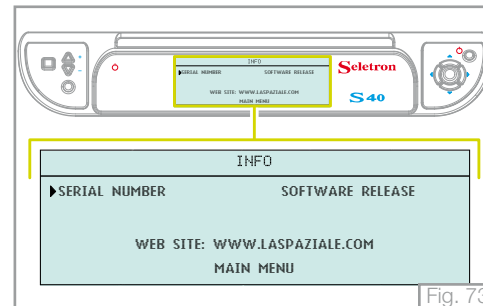

Fig. 73

6.5.1 Serial number

Using the navigation touchpad enter the “Info” menu, select the “Serial number” menu and press the “OK” key to gain access.

The main display visualises the machine’s serial number.

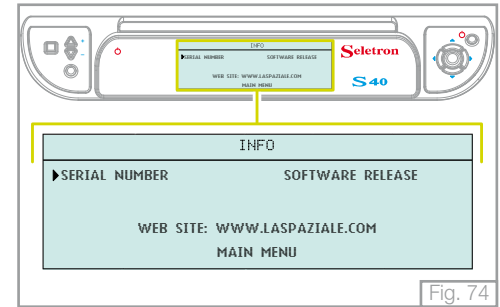

Fig. 74

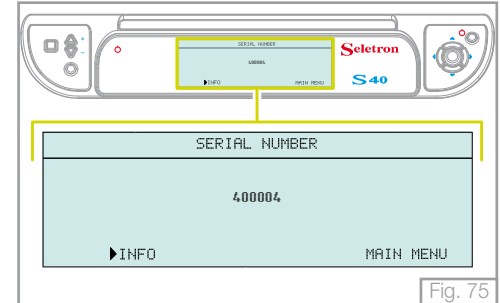
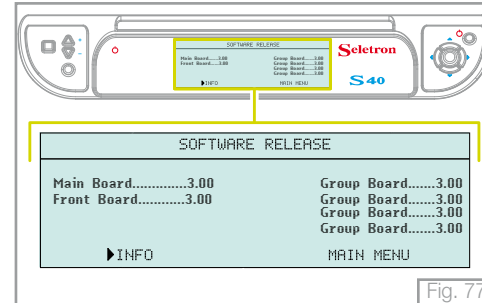
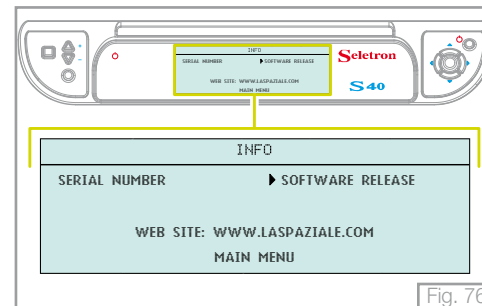

Fig. 75

6.5.2 Software release

Using the navigation touchpad enter the “Info” menu, select the “Software release” menu and press the “OK” key to gain access.

The main display visualises a viewing panel in which all versions of the various firmware in the machine are present.



6.6 BEEP

From the **“Main Menu”** screen, use the navigation touchpad to select the **“Beep”** menu and press **“OK”** to open it.

The display visualises the possibility of activating/deactivating the audible warning associated to pressing certain keys and the appearance of alarm messages.

The function is enabled by default.

Using the navigation touchpad, position the cursor on the desired parameter and press the **“OK”** key to select it.

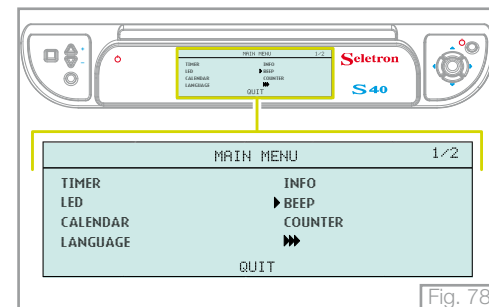

Fig. 78

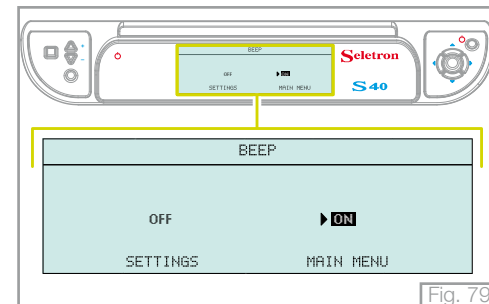

Fig. 79

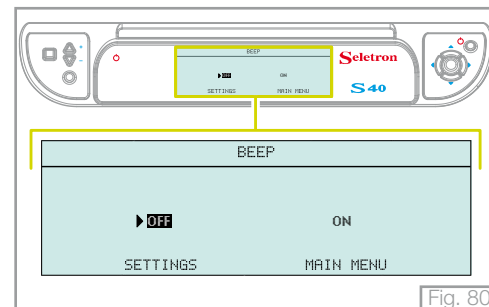

Fig. 80

6.7 COUNTER

This function has the purpose of counting the number of deliveries supplied during the life cycle of the machine.

Using the navigation touchpad enter the **“Main menu”**, select the **“Counter”** menu and press the **“OK”** key to gain access.

The menu visualises an initial viewing panel in which the partials and totals of the deliveries of coffee, water for infusions and cappucini are indicated.

The cursor is already positioned on **“Coffee”**; pressing the **“OK”** key, a viewing panel is visualised in which the total and partial deliveries are indicated and subdivided into the various coffee dispensing groups of the machine

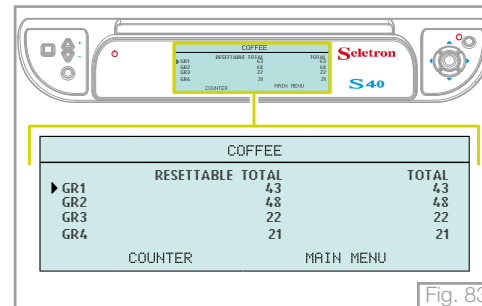
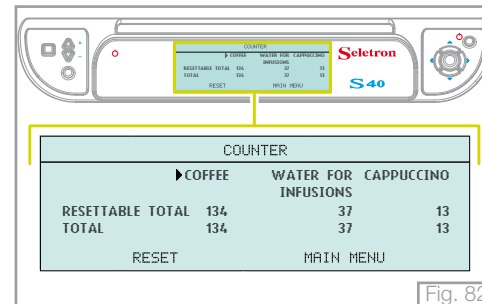
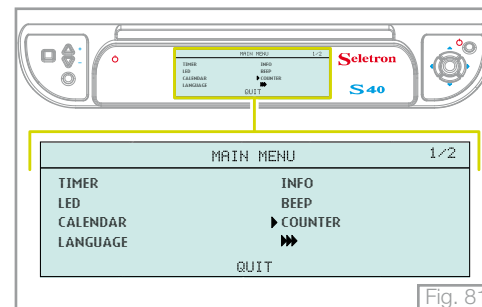

Position the cursor on a pre-chosen coffee dispensing group. Press the “OK” key and the total and partial deliveries subdivided by doses are visualised

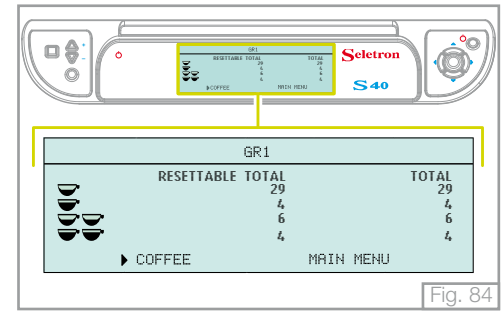

Fig. 84

Positioning the cursor on “Coffee” and then on “Counter”, the first viewing panel “Counter” returns.

Positioning the cursor on “Water for infusions” and pressing the “OK” key, the calculation of the deliveries of water for infusions is visualised.

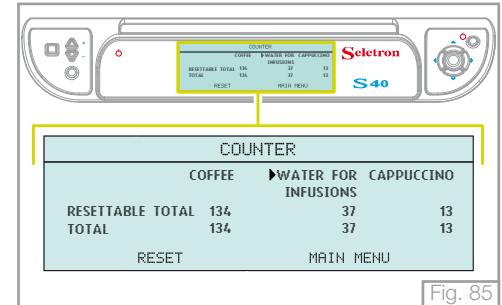

Fig. 85

Pressing the “OK” key, the total and partial deliveries of hot water and mixed water are visualised

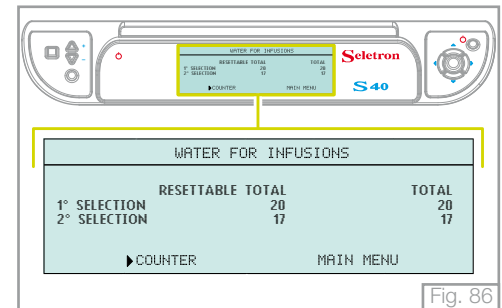

Fig. 86

Positioning the cursor on “Counter” and pressing the “OK” key, the first viewing panel “Counter” returns.

Positioning the cursor on “Cappuccino” and pressing the “OK” key, the calculation of the deliveries supplied by the M.A.T. system are visualised

Pressing the “OK” key, the total and partial deliveries of cappuccino relative to the first and second selection are visualised.

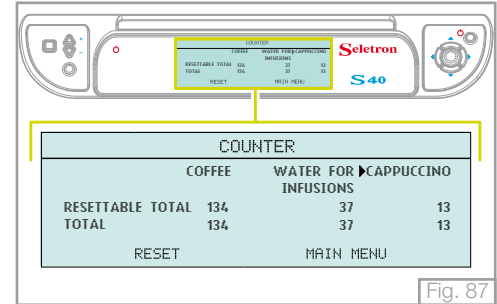

Fig. 87

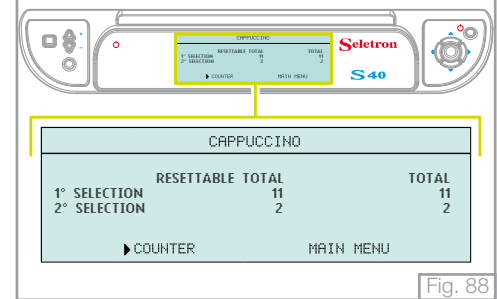

Fig. 88

6.7.1 Reset counter

In the main “**Counter**” viewing panel, position the cursor on “**Reset**” and press the “**OK**” key to zero all partial calculations memorised by the machine.

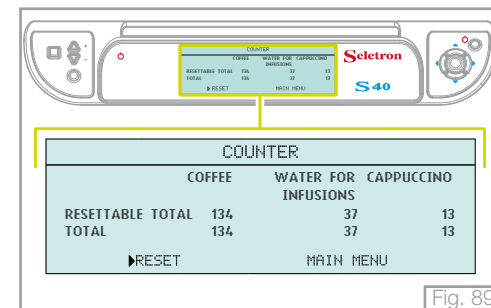

Fig. 89

When a request for a confirmation appears, press the “**OK**” key again to proceed.

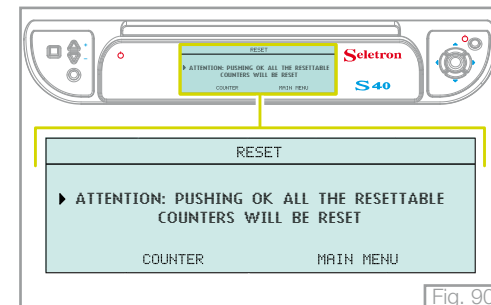

Fig. 90

The machine then proceeds to zero all partial calculations of the deliveries and the display advises that reset is in progress.



Take note!

Total calculations cannot be zeroed.

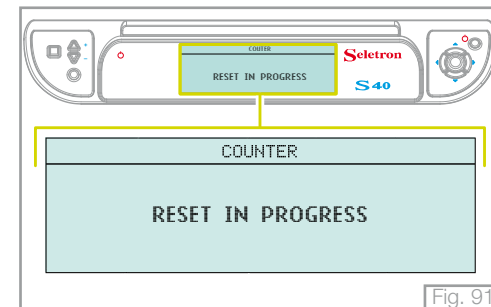

Fig. 91

6.8 GRINDING CONTROL

This function advises the operator if extraction times are not correct by referring to the previously memorised data.

From the “**Main Menu**” screen, use the navigation touchpad to select the “**Grinding Control**” menu and press “**OK**” to open it.

The display visualises the possibility of activating/deactivating the control of the amount of coffee grinding.

This function is disabled by default.

To activate the function, position the cursor on “**ON**” and press the “**OK**” key to confirm.

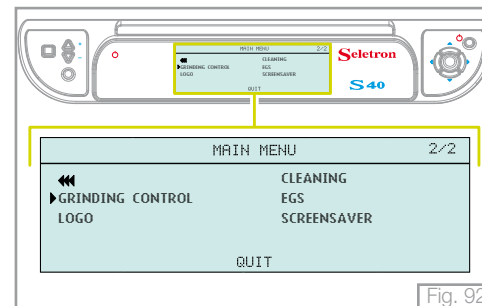

Fig. 92

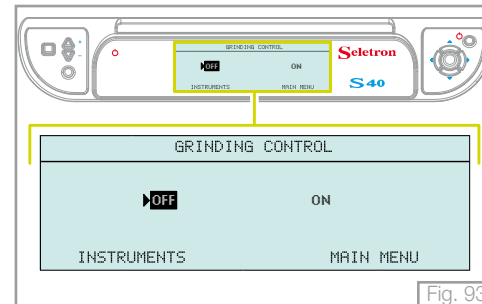

Fig. 93

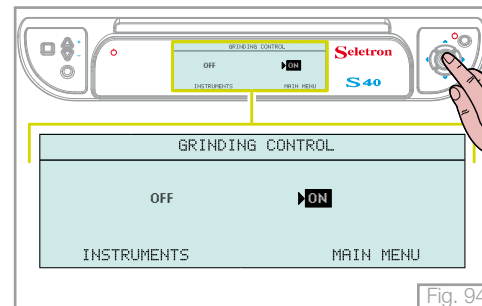
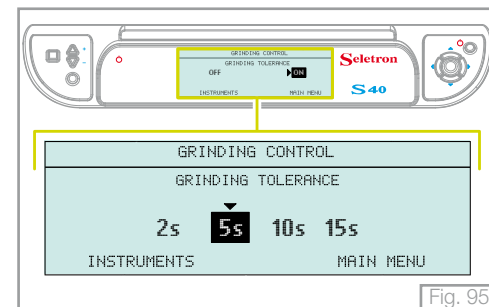

Fig. 94

Once the function is activated, select the tolerance (expressed in seconds) to be considered with regards to previously memorised parameters and press the “OK” key.

- E.g.**
- Memorised extraction time - 25 sec.
 - Selection tolerance - 5 sec.
 - Coarse grinding advice with extractions < 20 sec.
 - Fine grinding advice with extractions > 30 sec.

Any coarse or fine grinding advices are visualised on the coffee dispensing group display when dispensing has terminated.



6.9 LOGO

This function is used to switch the logo over the display on or off.

From the “**Main Menu**” screen, use the navigation touchpad to select the “**Logo**” menu and press “**OK**” to open it.

This function is active by default.

To deactivate the function, position the cursor on “**OFF**” and press the “**OK**” key to confirm.

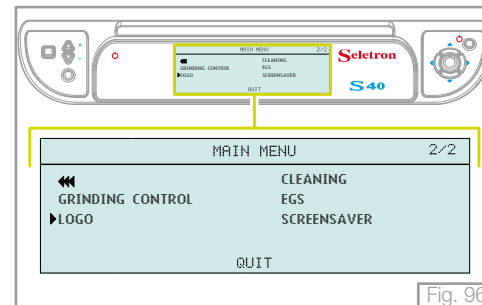

Fig. 96

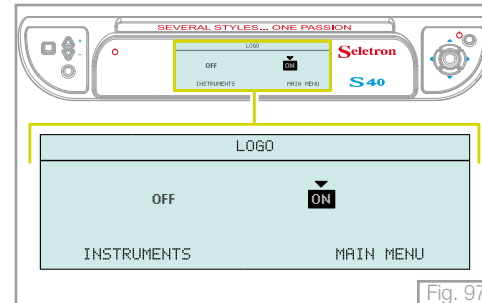

Fig. 97

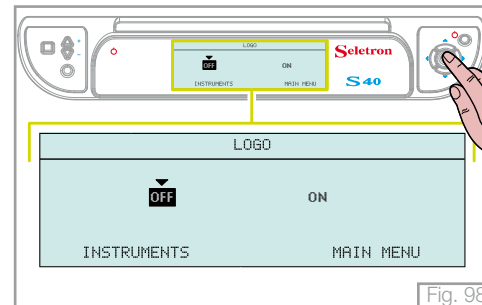

Fig. 98

6.10 CLEANING

From the “**Main Menu**” screen, use the navigation touchpad to select the “**Cleaning**” menu and press “**OK**” to open it.

The display visualises the possibility of activating the washing/cleaning of the coffee dispensing groups or the washing of the boiler.

- WASHING/CLEANING THE COFFEE DISPENSING GROUPS

In the “**Washing**” menu, the cursor is positioned on “**Group washing**”. Press the “**OK**” key to gain access

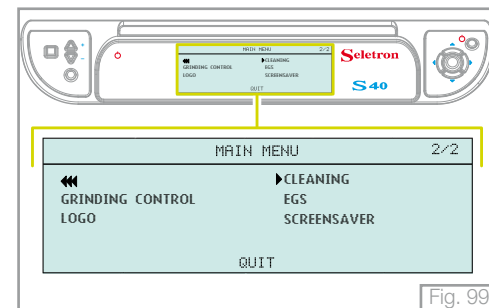

Fig. 99

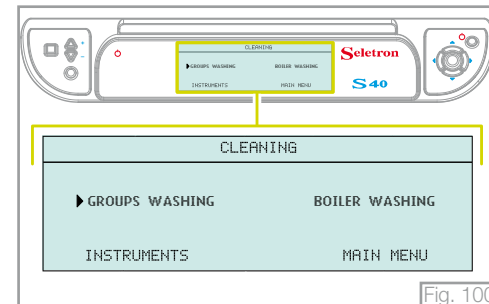

Fig. 100

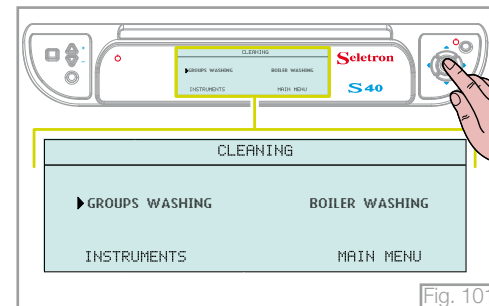

Fig. 101

The main display visualises the viewing panel on the right.

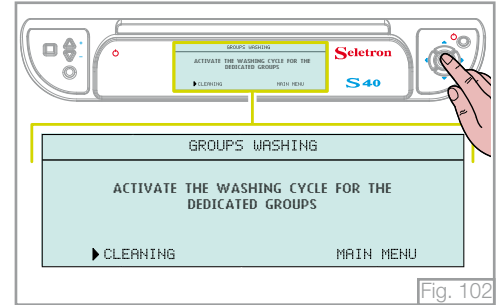

Fig. 102

The displays of the coffee dispensing groups visualise the viewing panel on the right.



Fig. 103

Press the “**Continuous delivery**” key to activate the washing cycle.

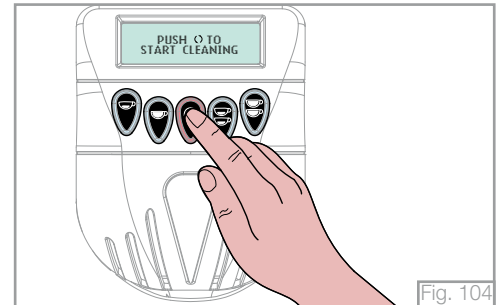

Fig. 104

The delivery group cleaning cycle consists of 5 seconds of water delivery from the groups with a 5-second pause, which allows the brush (provided) to be used as well as the blind filter supplied by the Technical Assistance Service.

The displays of the coffee dispensing groups visualise the viewing panel on the right.

Press the **“Continuous delivery”** key to conclude the washing cycle of the coffee dispensing groups

 **Take note!**

The deliveries made during the washing cycle are not taken into account in the counter menu.

- WASHING/CLEANING THE BOILER

In the **“Washing”** menu, position the cursor on **“Wash boiler”** and press the **“OK”** key to gain access

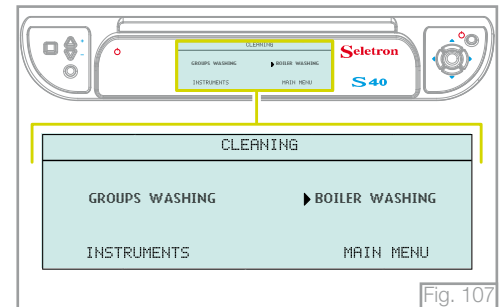

Subsequently, a viewing panel confirming the operation appears.
Press the “OK” key to activate the boiler washing cycle.

The main display indicates that the washing cycle of the boiler is in progress.

The machine completely empties the boiler and resets it. To stop the washing cycle in advance, press the “OK” key again.

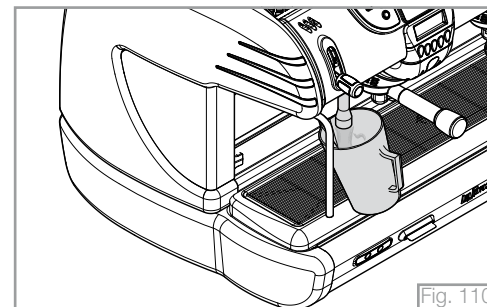
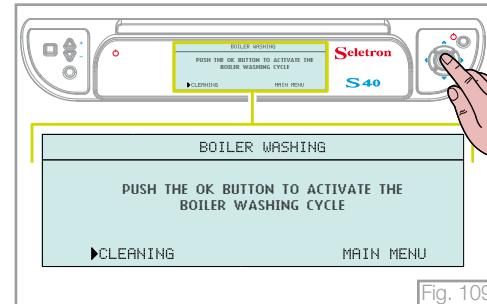
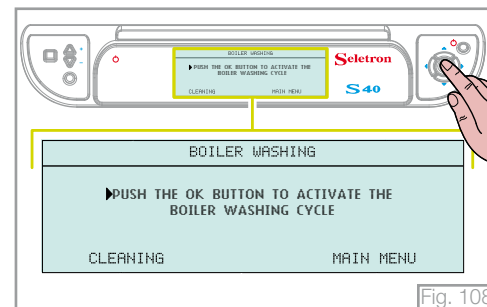

Take note!

Place a container underneath the hot water wand and slowly empty it.

Attention!

Wear protective gloves to avoid being burned.

Take note!

It is advisable to carry out the boiler washing cycle each day at the end of the work shift.

6.11 EGS

This function maintains the coffee pod moist that is used inside the filter holder in case it is not used for more than 30 minutes.

From the “**Main Menu**” screen, use the navigation touchpad to select the “**Egs**” menu and press “**OK**” to open it. The display visualises the possibility of activating/deactivating this function.

This function is not active by default.

To activate the function, position the cursor on “**ON**” and press the “**OK**” key to confirm

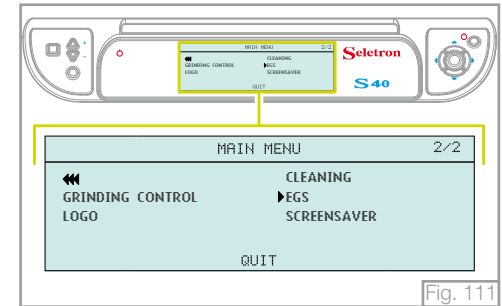

Fig. 111

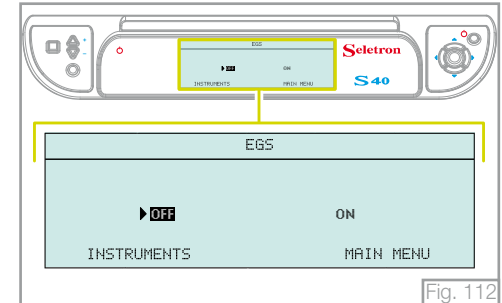

Fig. 112

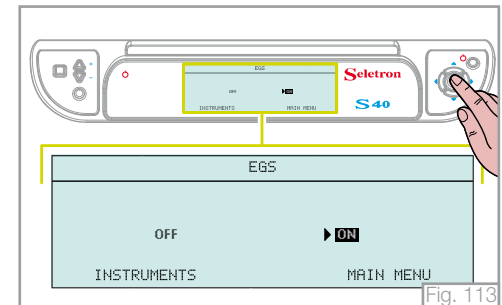

Fig. 113

With the EGS function active, a small quantity of water is poured into the filter holder every thirty minutes of inactivity of the coffee dispensing group so as to avoid excessive drying of the coffee grouts contained in it.

The active function is visualised on the left, upper part of the main display of the machine.

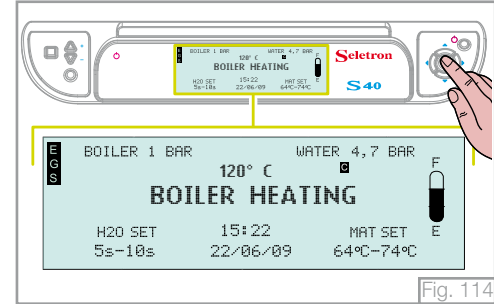

Fig. 114

The imminent activation of the cycle is signalled to the operator 30 seconds before by an acoustic signal and 15 seconds before by a further acoustic signal.

Attention!

Whilst the EGS cycle is functioning, do not remove the filter holders to avoid being burned by boiling water.



Fig. 115

6.12 SCREENSAVER

This function permits the composition of a message that will be visualised on the main display when the machine remains inactive for more than two minutes.

From the “**Main Menu**” screen, use the navigation touchpad to select the “**Egs**” menu and press “**OK**” to open it.

This function is not active by default.

Position the cursor on “**ON**” and press the “**OK**” key to enable the “**screensaver**” function.

Using the navigation touchpad, choose the letter or number to be composed and press the “**OK**” key.

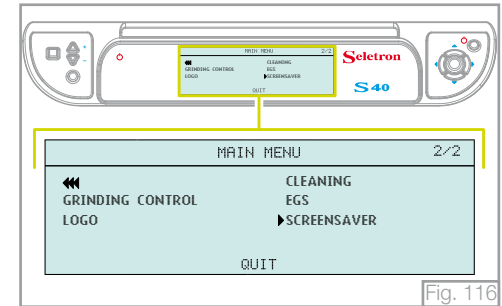

Fig. 116

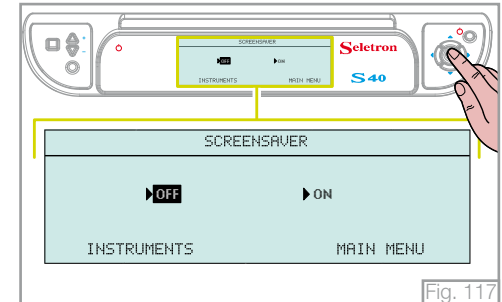

Fig. 117

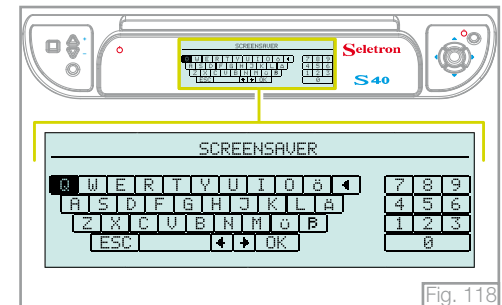

Fig. 118

The characters chosen are visualised in the “**text preview line**”. To cancel the last character, select the ← symbol and press the “**OK**” key.

To modify the text use the navigation touchpad to select the ← → symbols, press the “**OK**” key and the cursor of the “**text preview line**” moves. It is now possible to cancel a character of the text or add another.

Selecting the “**ESC**” symbol, the display visualises the previous menu.
 Selecting the “**OK**” key, the text is visualised on the main display (in a scrolling mode) when the machine remains inactive for more than two minutes.

If no message is composed, the screensaver function remains inactive after pressing the “**OK**” key.

In the case of deliveries, messages or alarms, the visualisation of the text is interrupted.

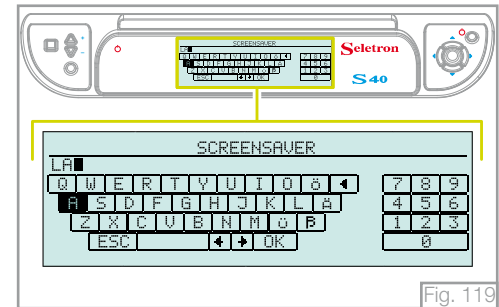

Fig. 119

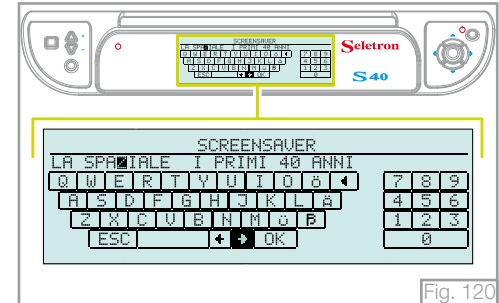

Fig. 120

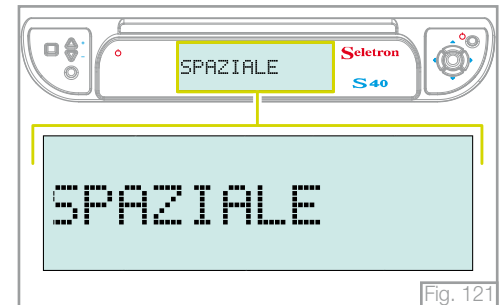

Fig. 121

7. SOFTWARE UPDATING

The machine's software can be updated by utilising an SD card (not supplied as standard).

To update the software, copy the file with the ".bin" extension onto a memory card and proceed as described.

Attention!

Do not rename the ".bin" file because it will no longer be recognised by the machine.

For further information, visit the www.laspaziale.com website.

With the main switch in the "0" position (machine switched off), insert the SD card with the contacts facing down into the appropriate reader under the machine.

Once the card has been inserted, switch on the machine using the main switch.

Warning!

Do not switch off the machine during all the following operations.

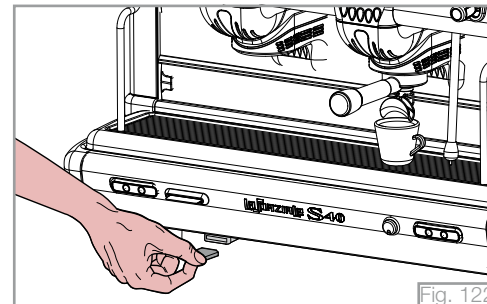

Fig. 122

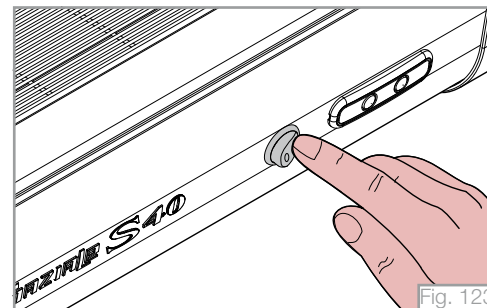
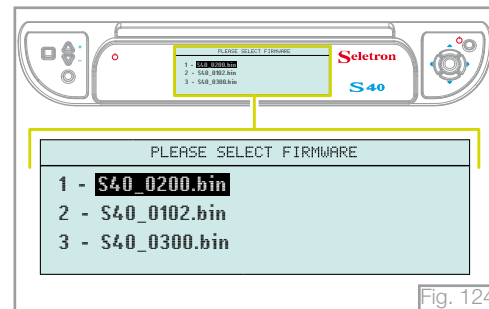

Fig. 123

The main display visualises all files that are present on the SD card that correspond to the file name structure "S40_XXYY.bin", where XX and YY correspond to the software revision.

Using the navigation touchpad, select the software to update the machine and press the "OK" key to confirm



The software is copied from the SD card to the CPU of the machine

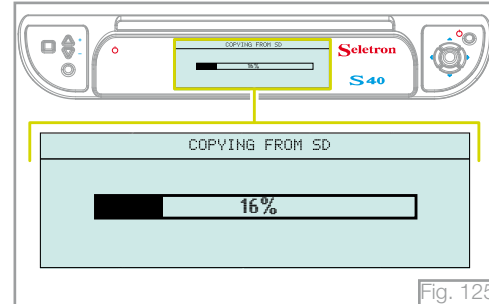

Subsequently the software is transmitted from the power CPU to all the EEPROMs in the machine.

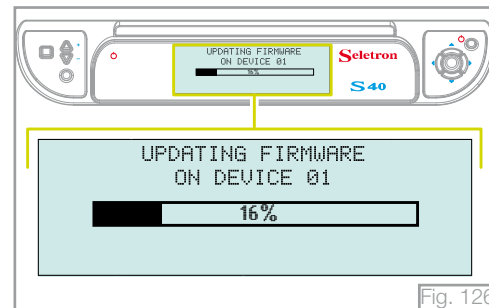

The following viewing panel appears when the copying of the software has finished.

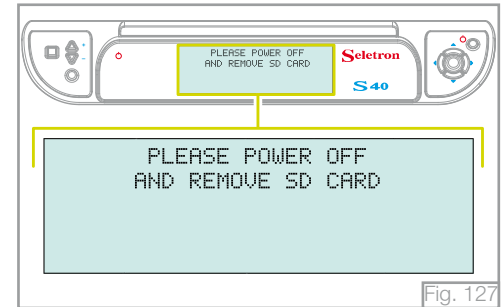

Switch off the machine.

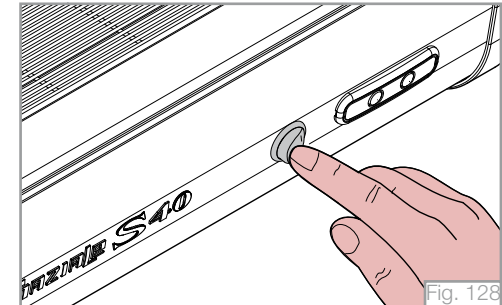

Remove the SD card from the reader

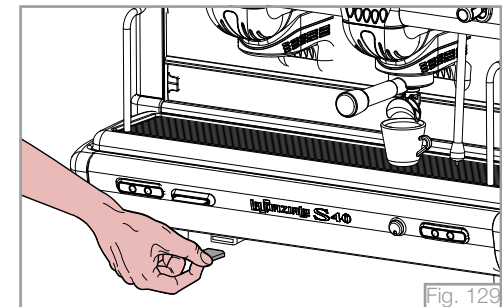

8. ROUTINE APPLIANCE MAINTENANCE TO BE PERFORMED BY THE USER

Take note!

To grant the efficiency of the appliance and to maintain correct operation, it is necessary to follow the manufacturer's instructions as to cleaning and regular maintenance.

Attention!

Cleaning and routine maintenance operations must be carried out by the user according to the manufacturer's instructions given here below. Before carrying out any cleaning operations, disconnect the appliance from the mains power. Cleaning and routine maintenance operations must be carried out when the machine is cold and using protective gloves to prevent abrasions.

8.1 DAILY AT THE END OF THE JOB

1. Replacing the water in the boiler (**See paragraph 6.10 "CLEANING", page 59**).
2. Then clean the filter holders and the filters with the brush provided, making sure no dirt is left inside the filter holders and that all filter holes are clean.

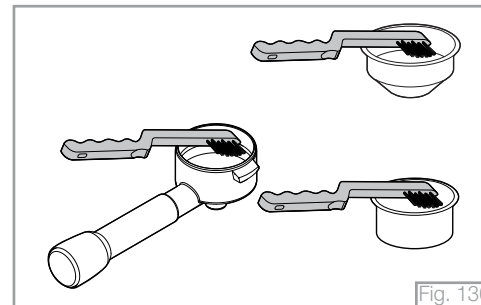
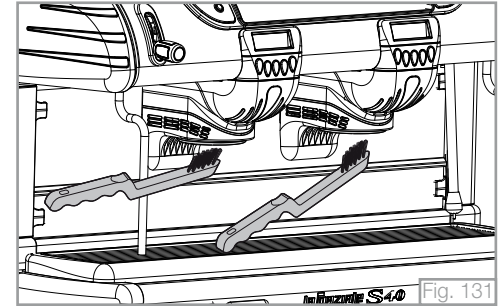
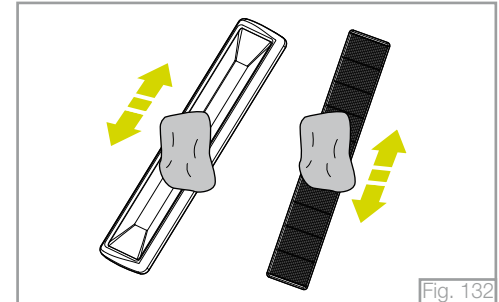

Fig. 130

3. Clean the delivery groups (See paragraph 6.10 "CLEANING" on page 59).
Also clean the shower heads under the groups between one delivery and the next using the brush.



4. Clean the basin and the cup grille using standard detergent, if necessary.



8.2 EVERY TWO WEEKS

1. After turning off the machine, remove the shower heads using the wrench provided; brush them carefully, making sure that all the holes are clean. Then reassemble the parts following the sequence shown in the figure.
 - a. Fastening screw
 - b. Small shower head
 - c. Large shower head
 - d. Diffuser
 - e. Delivery group

Attention!

Every day, at the end of work and after daily cleaning, turn off the appliance using the electric switch; then close the water supply tap and the gas tap (if fitted).

Warning!

Do not use water jets to clean the machine.

3. WATER SOFTENER

If the installation of a water softener has been recommended by the installation engineer because of hard water and problems of scale deposits, it is necessary to follow the instructions of the water softener's manufacturer (periodic regeneration).

3. BODYWORK

Clean the bodywork of the appliance using mild detergent to prevent any damage.

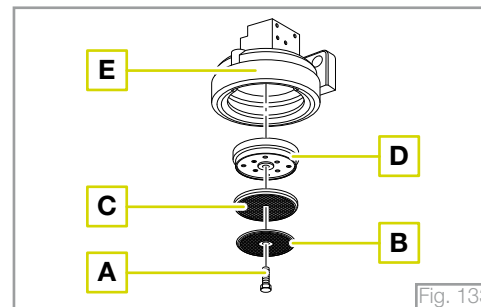

9. LIST OF PROGRAMMABLE FUNCTIONS (TECHNICAL ASSISTANCE SERVICE ONLY)



Take note!

For access and programming procedures for appliance functions, see the Installation Instruction Manual.

■ **SETTINGS MENU**

The “**Settings**” menu has two screens for the parameters to be programmed.

■ **Water mains menu**

The appliance is equipped with a pressure sensor to check the pressure from the water mains on a constant basis.

■ **Cup warmer set menu**

This function is used to change the reference temperature for the heat settings of the cup rack.

■ **Free flow**

This function is used to disable the free flow key



of the coffee delivery groups in order to carry out a correct calculation of the number of coffees delivered.

■ **Pin menu**

This function serves to use a password to access appliance programming stages (Technical Assistance Service).

■ **Motor pump pressure sensor menu**

The appliance is equipped with a pressure sensor that can be used to check the motor pump pressure on a constant basis.

■ **Water level control menu**

This function serves to prepare the appliance to detect water in the boiler by means of a conduction probe or magnetic float.

- **Installation date menu**

It is possible to enter the installation date and to store it to the appliance memory for future reference.

- **Factory settings menu**

The display can be used to restore all of the factory settings for the appliance.

- **PROGRAM MENU**

The “Program” menu contains a screen relevant to some appliance parameters that need setting.

- **Boiler temperature**

This function is used to set the working temperature for the boiler.

- **M.A.T. system temperature (optional)**

The appliance can be equipped with a system for automatic milk emulsifying at a controlled, adjustable temperature. The display shows the possibility to set the heating temperature of the milk according to the two available selections.

- **Auto calibration**

This function serves to calibrate the temperature probe of the boiler based on the appliance pressure sensor.



Take note!

Only use this function in case of replacing the temperature probe and/or the main CPU.

- **Coffee doses menu**

The display shows the possibility to program the coffee doses for the appliance groups.

- **Hot water doses menu**

The display shows the possibility to program the hot water doses automatically or semi automatically. Selecting semiautomatic delivery, the relevant button operates semi automatically (ON/OFF) and not timed. Selecting automatic delivery for hot water doses sets the automatic wand delivery times.

- **Boiler sensor menu**

The display shows the possibility to calibrate the appliance pressure sensor.

- **SERVICE MENU**

The “Service” menu contains a screen for the parameters to be set on the appliance.

- **Alarms menu**

This shows the list of alarms that have intervened on the machine, including the date, time and the description of the alarm itself.

- **Tech. service menu**

This shows the list of technical services performed on the machine, including the date and the description of the interventions.

- **Access menu**

This shows the list of ID accesses made using the Service card.

■ INSTRUMENTS MENU

The “Instruments” menu has two screens for the parameters to be programmed.

■ Compensation menu

This function is used to automatically compensate the boiler temperature on the appliance based on the variations in the ambient temperature in the area in which it is installed.

■ Boost menu

The display shows the possibility to enable the “BOOST” function manually or automatically.

■ Itc menu

This system makes it possible to set a different water temperature for coffee infusion on each delivery group.
The display shows the possibility to enable the system for each group and each selection.

■ Technical assistance menu

This function makes it possible to program scheduled servicing intervals.

Accessing “Service” accesses the possibility to enter the number of delivery cycles to be made before the service intervention (routine technical servicing).

Accessing “Filter” offers the possibility to monitor the water consumption envisaged before replacing any cartridge filter.

■ INFO MENÙ

The “Info” menu contains a screen with all of the main information concerning the appliance.

■ Testing date menu

When this menu is opened, the main display shows the date on which the machine was tested.

■ Installation date

When this menu is opened, the main display shows the previously stored date on which the machine was installed.

■ SOFTWARE UPGRADE

It is possible to upgrade the appliance software using an SD card (not provided).

10. MANAGEMENT OF THE ALARMS

10.1 ALARM MESSAGES VISUALISED ON THE MAIN DISPLAY

■ EEPROM DEFAULT LOADED ON MAIN BOARD

This message is visualised when the power CPU cannot find the parameters memorised when installing the machine and a backup is not available in the front CPU. In this situation, the default data is reset.

■ DAY LIGHT SAVING TIME UPDATE

This message signals the change from summer time to winter time and vice versa.
This message automatically resets after 1 minute.

■ BACK UP RESTORE ON FRONT BOARD IN PROGRESS

The power CPU acquires the data memorised in the front CPU.

10.2 ALARM MESSAGES VISUALISED ON THE FRONT DISPLAY



Take note!

The alarm messages visualised on the main display are of two types; blocking and non-blocking.

The blocking messages interrupt the functioning of the machine. To reset the machine, it is necessary to switch the machine off and switch it on again using the stand-by key.

The non-blocking messages do not stop the machine from functioning and they are visualised on the display for 5 minutes.

After, the alarm message is substituted by a flashing  symbol to signal the presence of a malfunction in the machine. Pressing the "OK" key, the display visualises the alarm menu in which all non-blocking alarms of the machine are shown.

To reset the machine, it is necessary to switch the machine off and switch it on again.

All blocking and non-blocking alarms are also signalled by an acoustic beep.

10.2.1 Alarms relative to the auto-level system

The S40 SELETRON has a water refilling system that is managed by three electronic sensors*:

The minimum level sensor checks the presence of a minimum quantity of water in the boiler that is sufficient to cover the elements of the electrical resistances.

The * level sensor determines the level of water in the boiler preset by the manufacturer.

The maximum level sensor checks that the level of water in the boiler is not higher than that allowed.

When the water in the boiler does not reach the level of the minimum level sensor, the display visualises:



When the water in the boiler reaches the level of the minimum level sensor, the level indicator visualises:



When the water in the boiler reaches the level preset by the manufacturer, the level indicator visualises:



When the water in the boiler reaches the level of the maximum level sensor, the level indicator visualises:



* The electronic level sensor can be replaced by a mechanical/electrical float on request.

- **BOILER REFILL FAILED, PUSH OK alternating with LOW WATER LEVEL IN THE BOILER**

This alarm blocks the machine and can be reset by pressing the “OK” key.

This alarm intervenes when the refilling of the water in the boiler has exceeded the run time of the programmed time-out (6 minutes) and the water in the boiler has not reached the minimum level sensor.

Press the “OK” key to activate a second refilling cycle.

- **BOILER REFILL FAILED, PUSH OK**

This alarm does not block the machine and can be reset by pressing the “OK” key.

This alarm intervenes when the refilling of the water in the boiler has exceeded the run time of the programmed time-out (6 minutes).

Press the “OK” key to activate a second refilling cycle.

■ **DAMAGED WATER REFILL SYSTEM**

This alarm does not block the machine.

This alarm intervenes after the BOILER REFILL FAILED, PUSH OK alarm intervenes a second refilling cycle is activated and the water in the boiler does not reach the temperature level set by the manufacturer.

The alarm is visualised on the display for 5 minutes and is then substituted by the flashing  symbol that signals the presence of a malfunction in the machine.

In this machine status the hot water dispensing keys are disenabled but the machine continues to function until the LOW WATER LEVEL IN THE BOILER alarm intervenes.

■ **FAILED MINIMUM LEVEL SENSOR**

This alarm does not block the machine.

This alarm intervenes when, after a minimum level sensor fault has been detected, the machine detects the correct level of water in the boiler set by the manufacturer but not the presence of the minimum level of water permitted.

The alarm is visualised on the display for 5 minutes and is then substituted by the flashing  symbol that signals the presence of a malfunction in the machine.

■ **DAMAGED WATER REFILL SYSTEM alternating with FAILED MINIMUM LEVEL SENSOR**

This alarm does not block the machine.

This alarm intervenes when the machine is in a FAILED MINIMUM LEVEL SENSOR alarm status and the refilling of the water in the boiler has exceeded the run time of the programmed time-out (6 minutes).

■ **LOW WATER LEVEL IN THE BOILER**

This alarm blocks the machine.

This alarm intervenes when the water in the boiler reaches a level that is too low to continue to operate correctly due to a malfunction of the auto-level system.

■ **HIGH WATER LEVEL IN THE BOILER**

This alarm blocks the machine.

This alarm intervenes when the water in the boiler reaches the maximum sensor level due to a malfunction of the auto-level solenoid valve.

When this alarm intervenes, the machine is disconnected from the mains water system by the closure of a water inlet solenoid valve.

■ **CUT OFF BOILER TEMPERATURE PROBE**

This alarm does not block the machine.

This alarm intervenes when the boiler temperature sensor is interrupted.

The alarm is visualised on the display for 5 minutes and is then substituted by the flashing  symbol that signals the presence of a malfunction in the machine.

When the temperature sensor is faulty, the thermostat regulation of the machine is taken over by the pressure sensor that recovers the pressure value corresponding to the set temperature value previously memorised during the programming phase (or corresponding to the last compensated temperature value) and maintains the temperature constant.

During this phase, the machine continues to function and it is not possible to modify the reference pressure value.

■ **SHORT CIRCUITED BOILER TEMPERATURE PROBE**

This alarm does not block the machine.

This alarm intervenes when the boiler temperature sensor is short-circuiting.

The alarm is visualised on the display for 5 minutes and is then substituted by the flashing  symbol that signals the presence of a malfunction in the machine.

When the temperature sensor is faulty, the thermostat regulation of the machine is taken over by the pressure sensor that recovers the pressure value corresponding to the set temperature value previously memorised during the programming phase (or corresponding to the last compensated temperature value) and maintains the temperature constant.

During this phase, the machine continues to function and it is not possible to modify the reference pressure value.

■ **HIGH BOILER TEMPERATURE**

This alarm intervenes when the boiler temperature sensor detects a temperature greater than 130°C.

When this alarm intervenes, the machine is disconnected from the electrical mains supply by a circuit breaker switch.

The alarm resets when the temperature detected by the sensor re-enters within the normal parameters.

■ **BOILER TEMPERATURE NOT REACHED**

This alarm does block the machine.

This alarm intervenes when the temperature detected by the sensor in the boiler has not yet reached 50°C. 20 minutes after switching on (either in manual mode or in TIMER mode).

■ **CUT OFF GROUPS TEMPERATURE PROBE**

This alarm does not block the machine.

This alarm intervenes when the coffee dispensing groups' ambient temperature sensor is interrupted.

The alarm is visualised on the display for 5 minutes and is then substituted by the flashing  symbol that signals the presence of a malfunction in the machine.

When this alarm intervenes the COMPENSATION function is disenabled (if it is active it becomes disenabled) and the GROUPS HIGH TEMPERATURE and the GROUPS VERY HIGH TEMPERATURE alarms are not managed

■ **SHORT CIRCUITED GROUPS TEMPERATURE PROBE**

This alarm does not block the machine.

This alarm intervenes when the coffee dispensing groups' ambient temperature sensor is short-circuiting.

The alarm is visualised on the display for 5 minutes and is then substituted by the flashing  symbol that signals the presence of a malfunction in the machine.

When this alarm intervenes the COMPENSATION function is disenabled (if it is active it becomes disenabled) and the GROUPS HIGH TEMPERATURE and the GROUPS VERY HIGH TEMPERATURE alarms are not managed.

■ **GROUPS HIGH TEMPERATURE**

This alarm intervenes when the temperature detected by the coffee dispensing groups' ambient temperature sensor is greater than the temperature set in the menu.

The alarm resets when the temperature re-enters within normal parameters.

■ **GROUPS VERY HIGH TEMPERATURE**

This alarm intervenes when the temperature detected by the coffee dispensing groups' ambient temperature sensor is greater than the temperature set in the menu.

The alarm resets when the temperature re-enters within normal parameters

■ **FAILED BOILER PRESSURE SENSOR**

This alarm does not block the machine.

This alarm intervenes if there is a fault in the boiler pressure sensor.

The alarm is visualised on the display for 5 minutes and is then substituted by the flashing  symbol that signals the presence of a malfunction in the machine.

If there is a fault in the boiler pressure sensor the auto-setting functions and the management of the thermostat are not available if there is a fault in the temperature sensor.

Furthermore, the controls managed by the sensor are disenabled.

■ **ALARM FOR FAILED THERMO REGULATION**

This alarm blocks the machine.

This alarm intervenes when the boiler temperature sensor and the boiler pressure sensor are simultaneously faulty.

The main display visualises the alternating messages CUT OFF BOILER TEMPERATURE PROBE or SHORT CIRCUITED BOILER TEMPERATURE PROBE and FAILED BOILER PRESSURE SENSOR for 1 minute. The ALARM FOR FAILED THERMO REGULATION message follows.

■ **AIR IN THE BOILER, OPEN THE STEAM WANDS**

This alarm does not block the machine.

This alarm intervenes when the boiler pressure sensor detects a pressure greater or equal to 0.5 bar and the temperature sensor detects a temperature less than 100°C.

The alarm resets when the pressure value re-enters within normal parameters.

■ **FAILED WATER PRESSURE SENSOR**

This alarm does not block the machine.

This alarm intervenes when the water pressure sensor is faulty.

The alarm is visualised on the display for 5 minutes and is then substituted by the flashing  symbol that signals the presence of a malfunction in the machine.

If the water pressure sensor is faulty the controls and alarms associated to it are not available.

■ **HIGH WATER PRESSURE**

This alarm does not block the machine.

This alarm intervenes when the water pressure sensor detects a pressure greater than 6 bar for 3 consecutive seconds.

The alarm is visualised on the display for 5 minutes and is then substituted by the flashing  symbol that signals the presence of a malfunction in the machine.

■ LOW WATER PRESSURE

This alarm does not block the machine.

This alarm intervenes when the water pressure sensor detects a pressure less than 1 bar for 3 consecutive seconds.

The alarm is visualised on the display for 5 minutes and is then substituted by the flashing  symbol that signals the presence of a malfunction in the machine.

■ HIGH PUMP PRESSURE

This alarm does not block the machine.

This alarm intervenes when the pressure sensor detects a pressure greater than 11 bar after 5 seconds of delivery.

The alarm automatically resets at the end of the delivery

■ LOW PUMP PRESSURE

This alarm does not block the machine.

This alarm intervenes when the pressure sensor detects a pressure greater than 6 bar after 5 seconds of delivery.

The alarm automatically resets at the end of the delivery.

■ NO WATER FEEDING

This alarm intervenes when the water pressure sensor detects a 0 bar pressure for 3 consecutive seconds.

The alarm resets automatically when the pressure value re-enters within normal parameters.

■ CUT OFF MAT TEMPERATURE PROBE

This alarm does not block the machine.

This alarm intervenes when the temperature sensor of the M.A.T. system is interrupted.

The alarm is visualised on the display for 5 minutes and is then substituted by the flashing  symbol that signals the presence of a malfunction in the machine.

If the steam wand temperature sensor is faulty the system continues to function in semi-automatic mode when operating either one of the steam dispensing keys. This means the system functions by pressing one of the steam dispensing keys to activate the delivery of steam and press it again to stop the delivery

■ SHORT CIRCUITED MAT TEMPERATURE PROBE

This alarm does not block the machine.

This alarm intervenes when the temperature sensor of the M.A.T. system is short-circuiting.

The alarm is visualised on the display for 5 minutes and is then substituted by the flashing  symbol that signals the presence of a malfunction in the machine.

If the steam wand temperature sensor is faulty the system continues to function in semi-automatic mode when operating either one of the steam dispensing keys. This means the system functions by pressing one of the steam dispensing keys to activate the delivery of steam and press it again to stop the delivery.

■ **CUT OFF CUP WARMER TEMPERATURE PROBE**

This alarm does not block the machine.

This alarm intervenes when the cup warmer temperature sensor is interrupted.

This alarm is visualised on the display for 5 minutes and is then substituted by the flashing  symbol that signals the presence of a malfunction in the machine.

If the cup warmer temperature sensor is faulty the cup warmer resistances function in semi-automatic mode. This means the system functions by pressing one of the cup warmer keys to activate the resistances and press it again to deactivate it.

When the cup warmer resistances are switched on in semi-automatic mode the increase/decrease warning lights flash.

■ **SHORT CIRCUITED CUP WARMER TEMPERATURE PROBE**

This alarm does not block the machine.

This alarm intervenes when the cup warmer temperature sensor is short-circuiting.

The alarm is visualised on the display for 5 minutes and is then substituted by the flashing  symbol that signals the presence of a malfunction in the machine. If the cup warmer temperature sensor is faulty the cup warmer resistances function in semi-automatic mode. This means the system functions by pressing one of the cup warmer keys to activate the resistances and press it again to deactivate it. When the cup warmer resistances are switched on in semi-automatic mode the increase/decrease warning lights flash.

■ **NO RECOGNIZED TAG**

This alarm does not block the machine.

This alarm intervenes when the machine does not recognise the TAG inserted.

The alarm is visualised on the display for 1 minute.

■ **FAILED TAG READER**

This alarm does not block the machine.

This alarm intervenes when the TAG reader is faulty.

The alarm is visualised on the display for 5 minutes and is then substituted by the flashing * symbol that signals the presence of a malfunction in the machine.

If the reader is faulty it is no longer possible to gain access to the programming menus.

- **FAILED BACK UP**

This alarm does not block the machine.

This alarm intervenes when the parameters memorised in the CPU are not copied into the TAG when making a backup copy using the TAG SERVICE.

- **FAILED RESTORE**

This alarm does not block the machine.

This alarm intervenes when the parameters memorised in the TAG are not copied to the CPU when effectuating a RESTORE DATA using the TAG SERVICE.

- **LOW POWER**

This alarm blocks the machine.

This alarm intervenes when the machine detects a voltage of 9 volts or less on the secondary circuit of the transformer.

The alarm resets automatically when the voltage re-enters within normal parameters.

- **HIGH POWER**

This alarm blocks the machine.

This alarm intervenes when the machine detects a voltage of 14 volts or more on the secondary circuit of the transformer.

The alarm resets automatically when the voltage re-enters within normal parameters.

- **FAILED CLOCK MODULE**

This alarm does not block the machine.

This alarm intervenes when the clock module is faulty.

- **NO COMMUNICATION WITH MAIN BOARD**

This alarm blocks the machine.

This alarm intervenes when the front CPU does not communicate with the power CPU.

- **ERROR COMMUNICATION GROUP 1**

The alarm intervenes when the power CPU cannot detect the presence of the 1st coffee dispensing groups' CPU.

- **ERROR COMMUNICATION GROUP 2**

The alarm intervenes when the power CPU cannot detect the presence of the 2nd coffee dispensing groups' CPU.

- **ERROR COMMUNICATION GROUP 3**

The alarm intervenes when the power CPU cannot detect the presence of the 3rd coffee dispensing groups' CPU.

- **ERROR COMMUNICATION GROUP 4**

The alarm intervenes when the power CPU cannot detect the presence of the 4th coffee dispensing groups' CPU.

10.3 MESSAGES VISUALISED ON THE COFFEE DISPENSING GROUPS' DISPLAYS



Take note!

All messages visualised on the coffee dispensing group displays are accompanied by an acoustic alarm.

- **VOLUMETRIC DOSING SYSTEM FAULTY**

The alarm intervenes during the phases of dose programming or coffee dispensing by a determine coffee dispensing group when the machine cannot detect the impulses generated by the volumetric counter.

The alarm resets at the end of the delivery.

- **FINE GRINDING**

The alarm intervenes when the machine detects that the coffee dispensing delivery time is more than the value set in the appropriate menu. The alarm resets 5 seconds after the delivery has finished.

- **GROSS GRINDING**

The alarm intervenes when the machine detects that the coffee dispensing delivery time is less than the value set in the appropriate menu. The alarm resets 5 seconds after the delivery has finished.

- **TOO FINE GRINDING**

This alarm intervenes when the machine detects a number of impulses generated by the volumetric counter that can only be explained by the presence of coffee that has been ground too fine.

- **ERROR COMMUNICATION FRONT BOARD**

This alarm blocks the machine.

The alarm intervenes when the power CPU cannot detect the front CPU.

All displays visualise this alarm message.

- **LACK OF COMMUNICATION WITH THE POWER CPU**

The alarm intervenes when the CPU of a determined coffee dispensing group cannot detect the presence of the power CPU.

- **LACK OF COMMUNICATION WITH THE FRONT CPU**

The alarm intervenes when the CPU of a determined coffee dispensing group cannot detect the presence of the front CPU.

- **DEFAULT DATA DOWNLOADED**

This message is visualised when the CPU of a determined coffee dispensing group cannot find the parameters memorised at the moment of installation. In this case the default data are reset.

- **MACHINE BLOCKED**

When the machine is blocked all coffee dispensing groups' displays visualise MACHINE BLOCKED.

11. TECHNICAL DATA

Dimensions Length x Height x Depth (mm)	845 x 600 x 560 (2 groups)
	1,078 x 600 x 560 (3 groups)
	1,311 x 600 x 560 (4 groups)
Weight (Kgs)	85 (2 groups)
	100 (3 groups)
	115 (4 groups)
Power supply rating and absorption (V - Hz)	230/400 - 50/60
	3200 (with Boost function active: 4600) 2 groups
	4200 (with Boost function active: 6200) 3 groups
	6200 (with Boost function active: 7200) 4 groups
Boiler capacity (litres)	10 (2 groups)
	15 (3 groups)
	20 (4 groups)

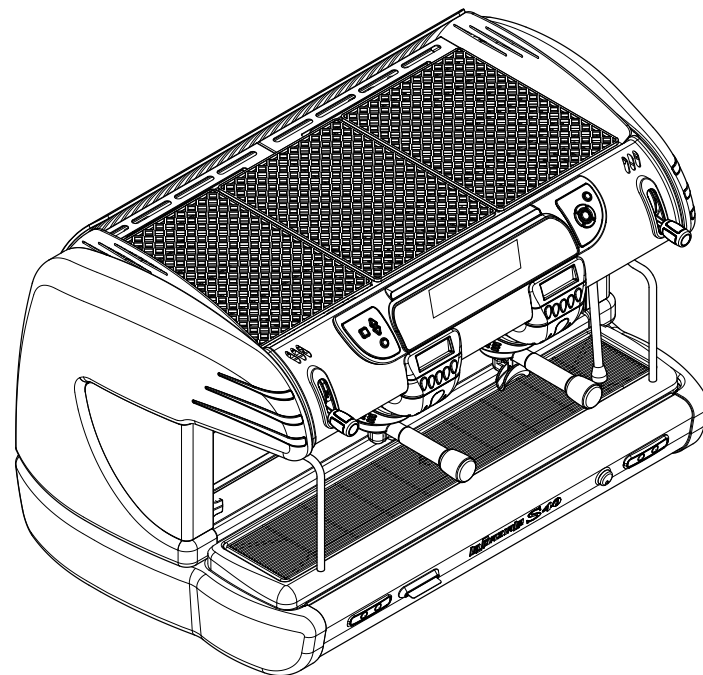



espresso coffee machines

La Spaziale S.p.A.

Via E. Duse, 8
40033 Casalecchio di Reno
Bologna - (Italy)

 +39 051 611.10.11

 +39 051 611.10.40

 info@laspaziale.com

 www.laspaziale.com